

SIRUBA®

銀爺牌工業用縫紉機

INDUSTRIAL SEWING MACHINE

Z008



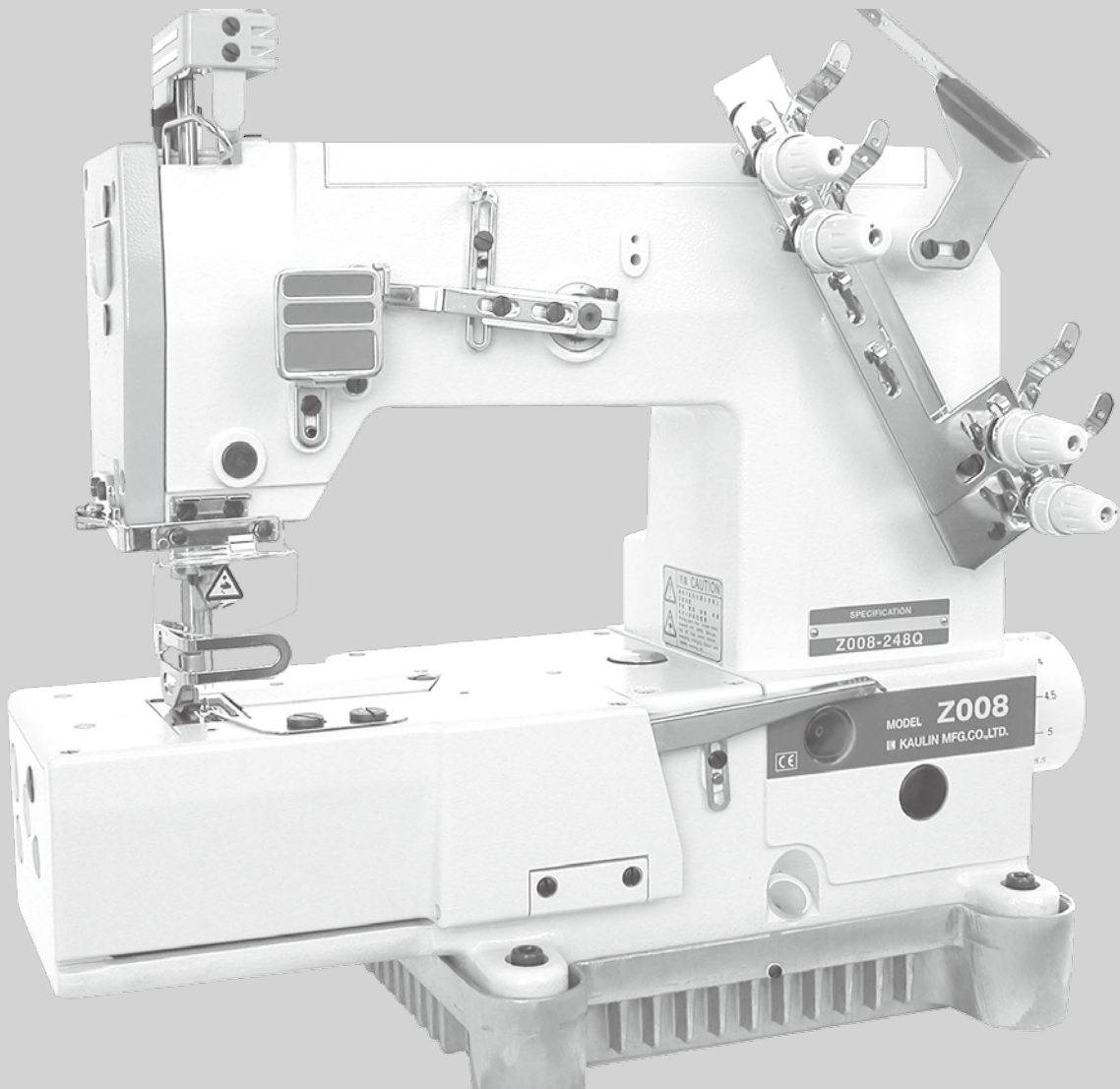

零件圖 PARTS LIST



CE

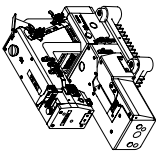
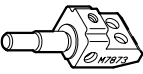
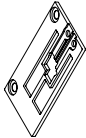
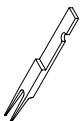
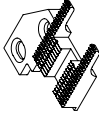

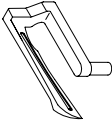
高林股份有限公司
KAULIN MFG. CO., LTD.

	機 型 MODEL		針 鉗 NEEDLE CLAMP		針 板 NEEDLE PLATE		針 舌 REAR NAIL		主送具 REAR FEED DOG		差動送具 FRONT FEED DOG		押 具 PRESSER FOOT		勾針組 LOOPER		針 號 NEEDLE
Z008-148P		M7873	M7873	E7873	E7873	E7873-1 E7873-2	E7873-1 E7873-2	D7873	D7873	H7873	H7873	P7872-A	P7872-A	ZD21-A	ZD21-A	U0163#11*1	U0163#11*1
Z008-148Z		M7873	M7873	E7871	E7871	無	無	D7871	D7871	H7871	H7871	P7871-A	P7871-A	ZD21-A	ZD21-A	U0163#11*1	U0163#11*1
Z008-248Q		M7873	M7873	E7873	E7873	E7873-1 E7873-2 E7873-3	E7873-1 E7873-2 E7873-3	D7873	D7873	H7873	H7873	P7872-A	P7872-A	ZD21-A ZD22-A	ZD21-A ZD22-A	U0163#11*2	U0163#11*2
Z008-248W		M7873	M7873	E7873	E7873	E7873-1 E7873-2 E7873-3	E7873-1 E7873-2 E7873-3	D7873	D7873	H7873	H7873	P7873-A	P7873-A	ZD21-A ZD22-A	ZD21-A ZD22-A	U0163#11*2	U0163#11*2
Z008-248X		M7873	M7873	E7873	E7873	E7873-1 E7873-2 E7873-3	E7873-1 E7873-2 E7873-3	D7873	D7873	H7873	H7873	P7873-A	P7873-A	ZD21-A ZD22-A	ZD21-A ZD22-A	U0163#11*2	U0163#11*2
Z008-248Y		M7873	M7873	E7873	E7873	E7873-1 E7873-2 E7873-3	E7873-1 E7873-2 E7873-3	D7873	D7873	H7873	H7873	P7873B-A	P7873B-A	ZD21-A ZD22-A	ZD21-A ZD22-A	U0163#11*2	U0163#11*2

規格件表 CONVERSION CHART

PARTS LIST FOR ZA GROUP

PARTS LIST FOR ZB GROUP

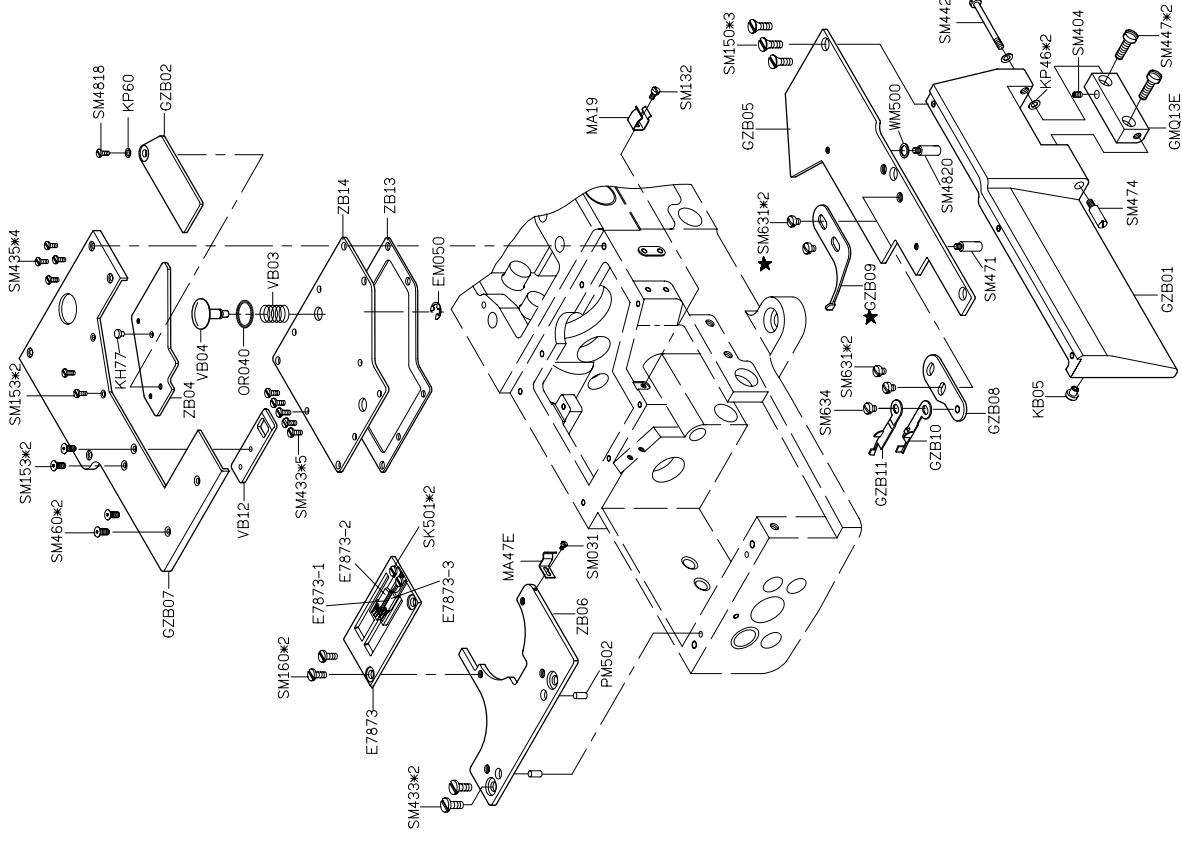
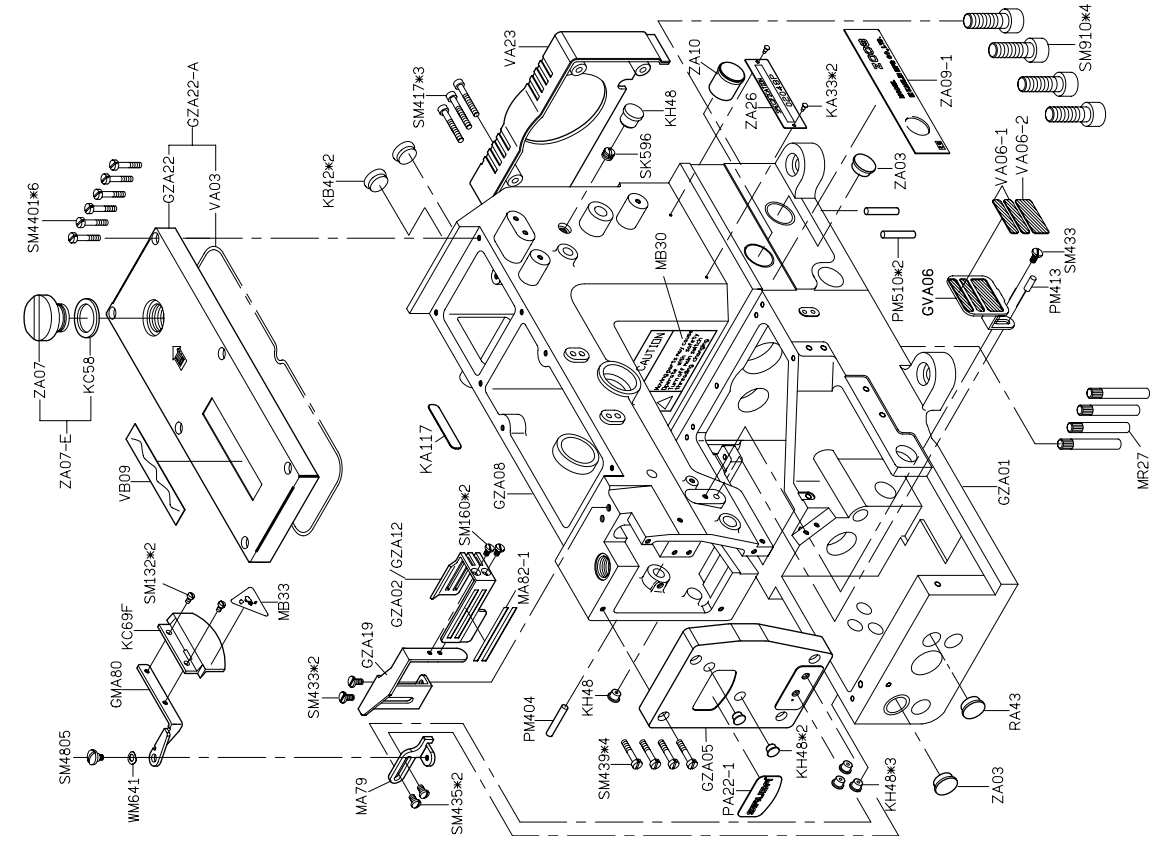

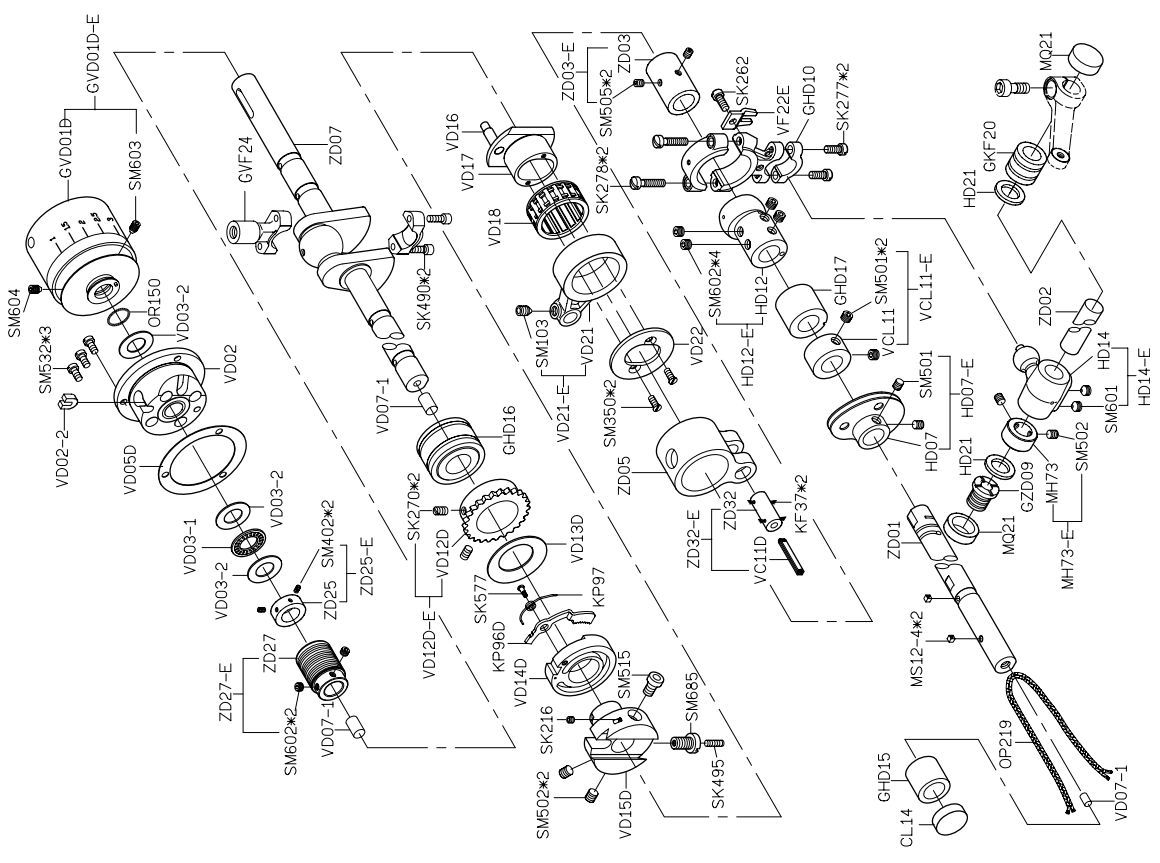

PARTS LIST FOR ZD GROUP

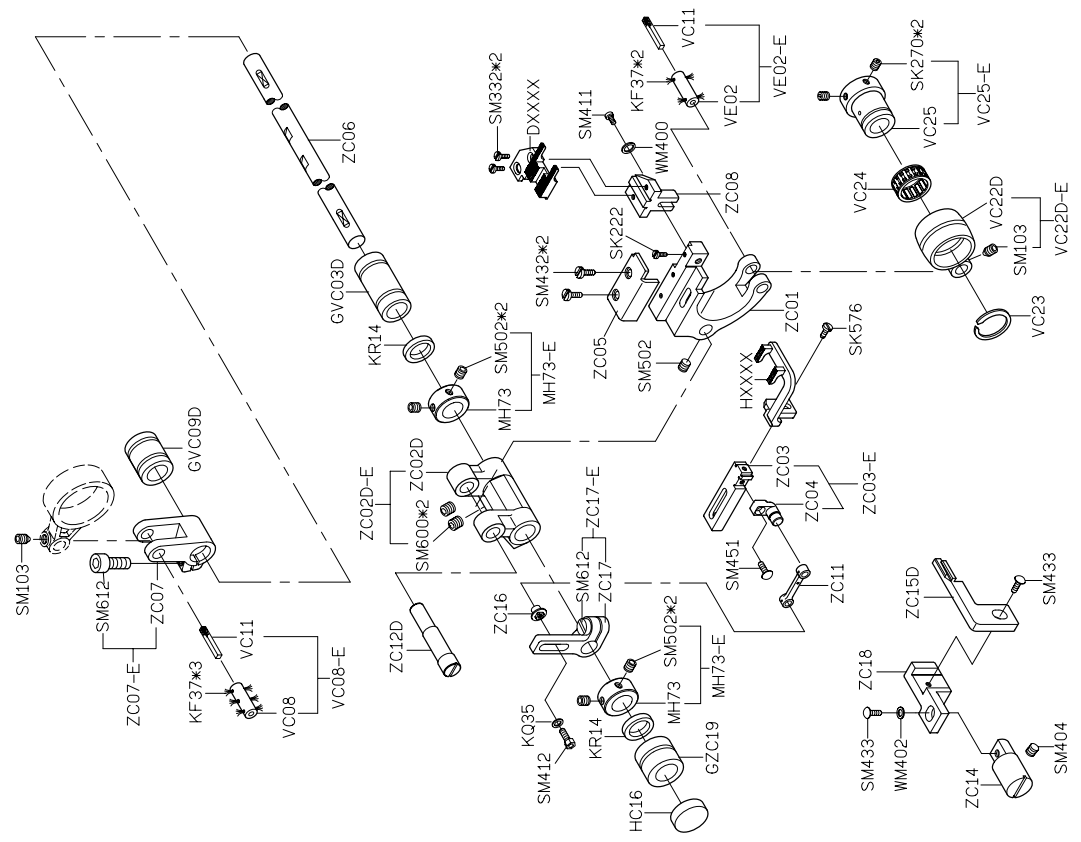

PARTS LIST FOR ZC GROUP

PARTS LIST FOR ZD GROUP

PARTS LIST FOR ZE GROUP

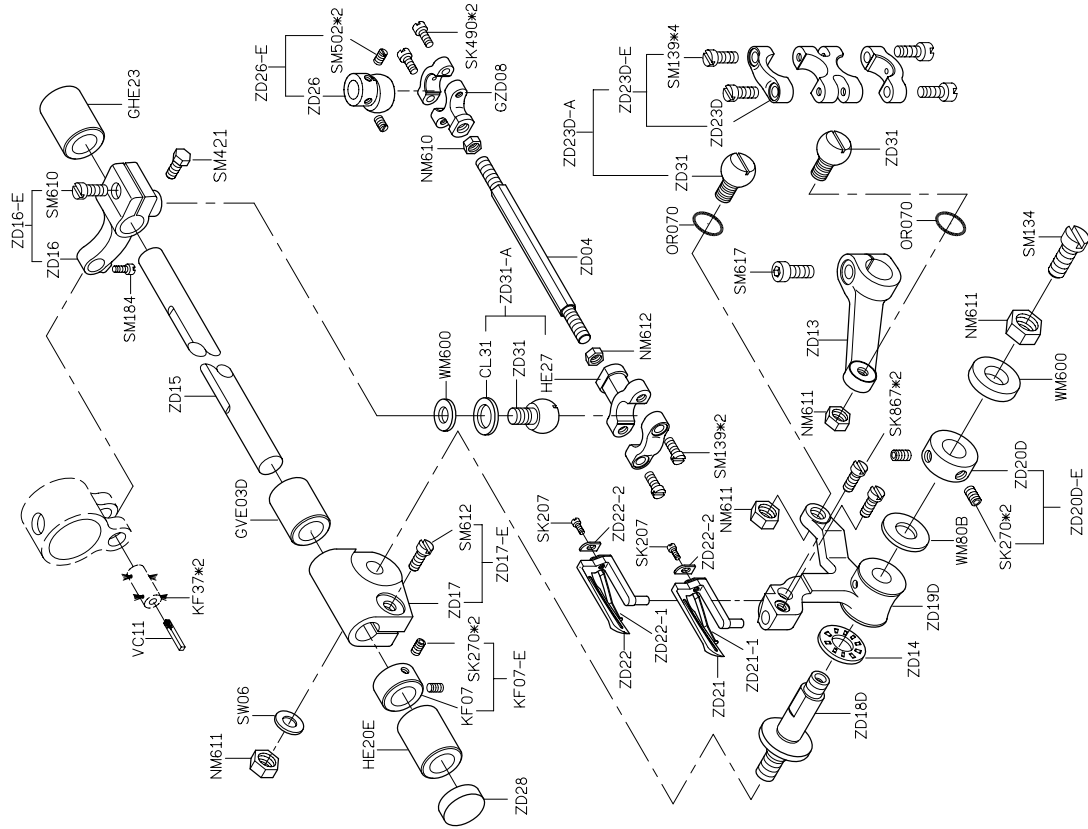
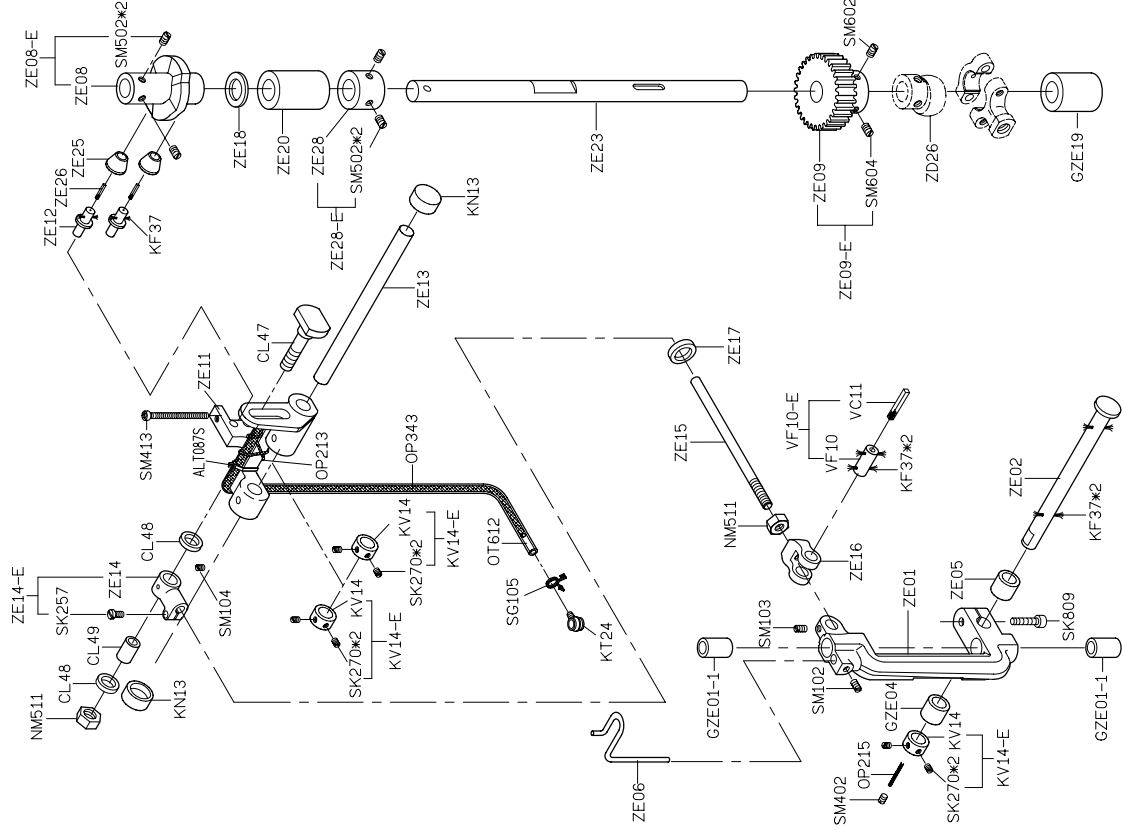

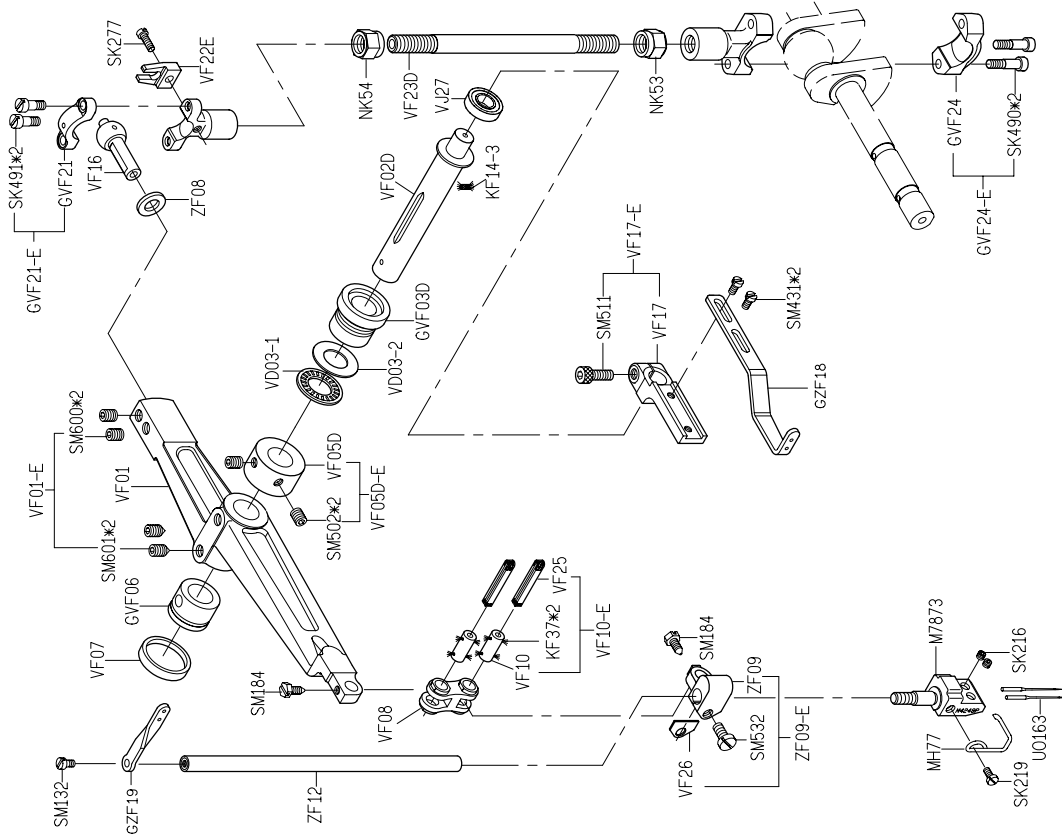
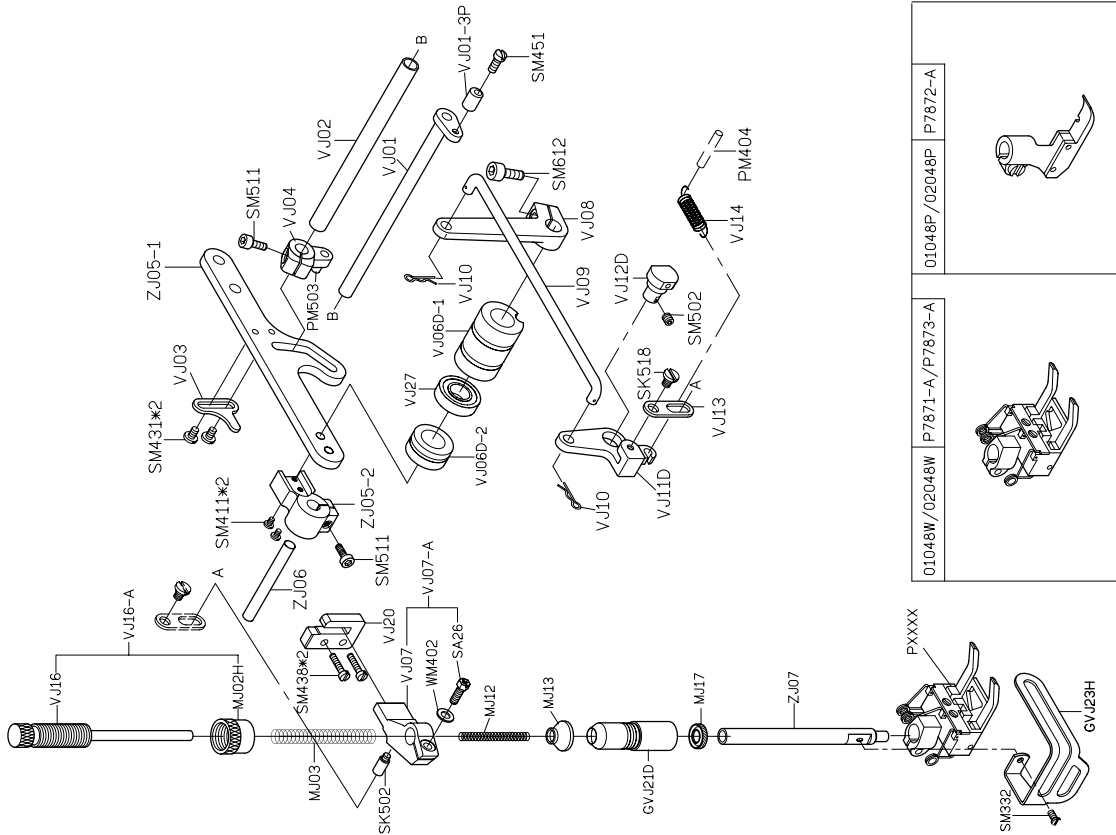

01048W/02048W	P7871-A/P7873-A	01048P/02048P	P7872-A

PARTS LIST FOR ZK GROUP

PARTS LIST FOR ZK GROUP

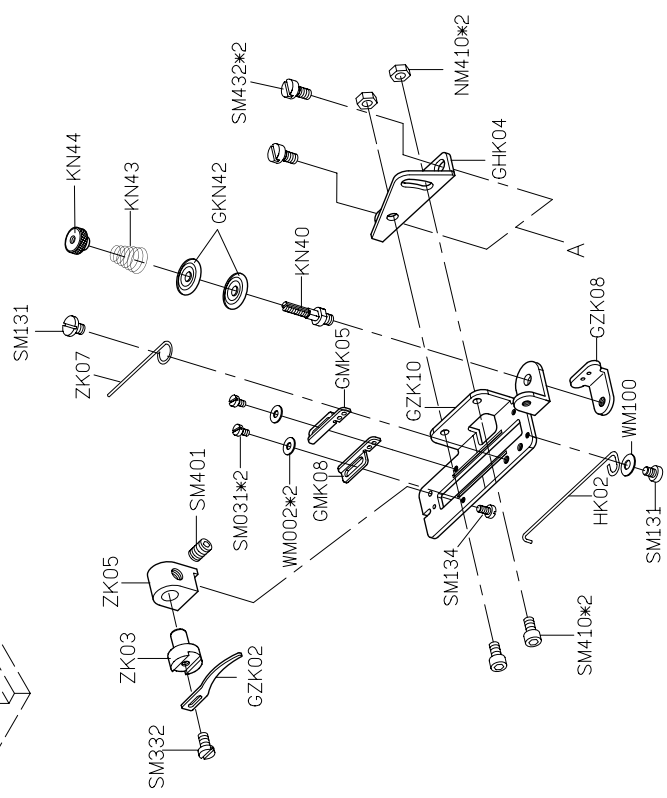
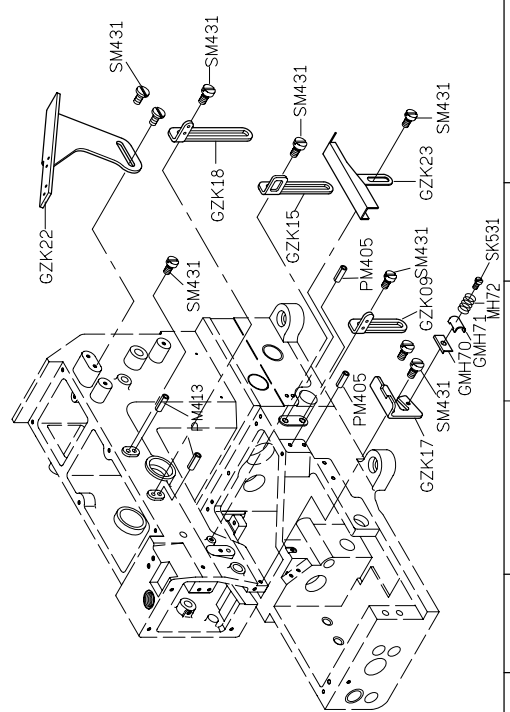
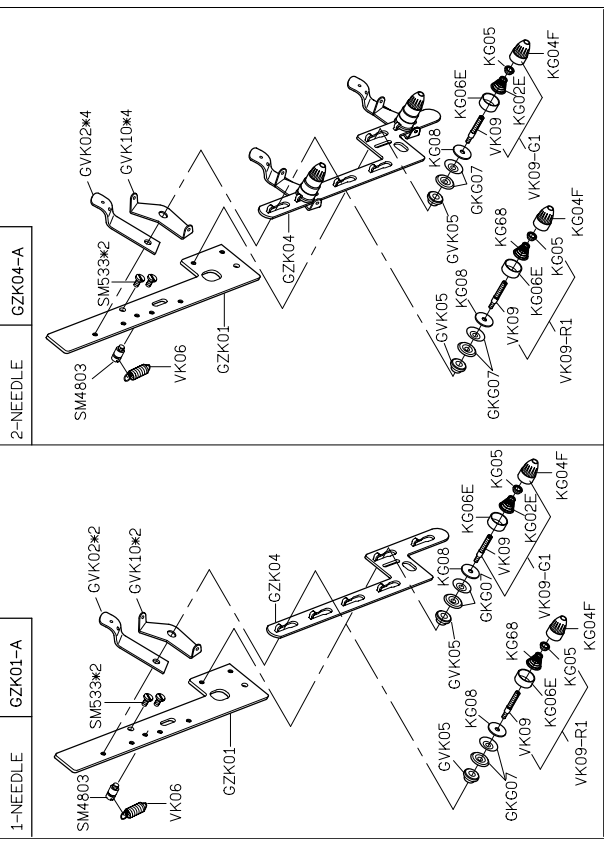
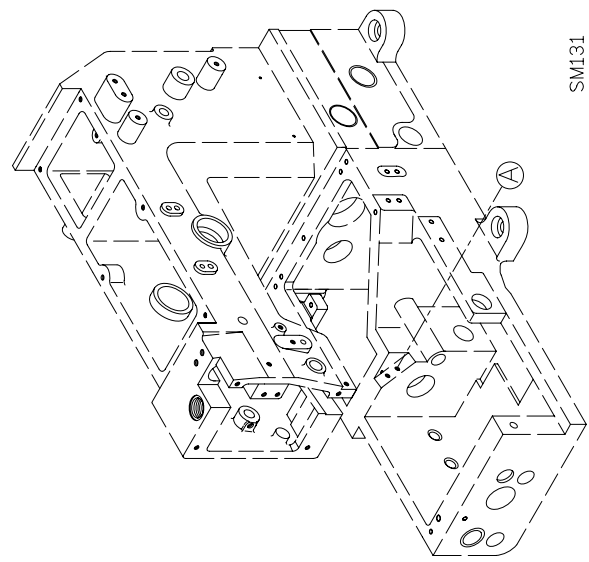

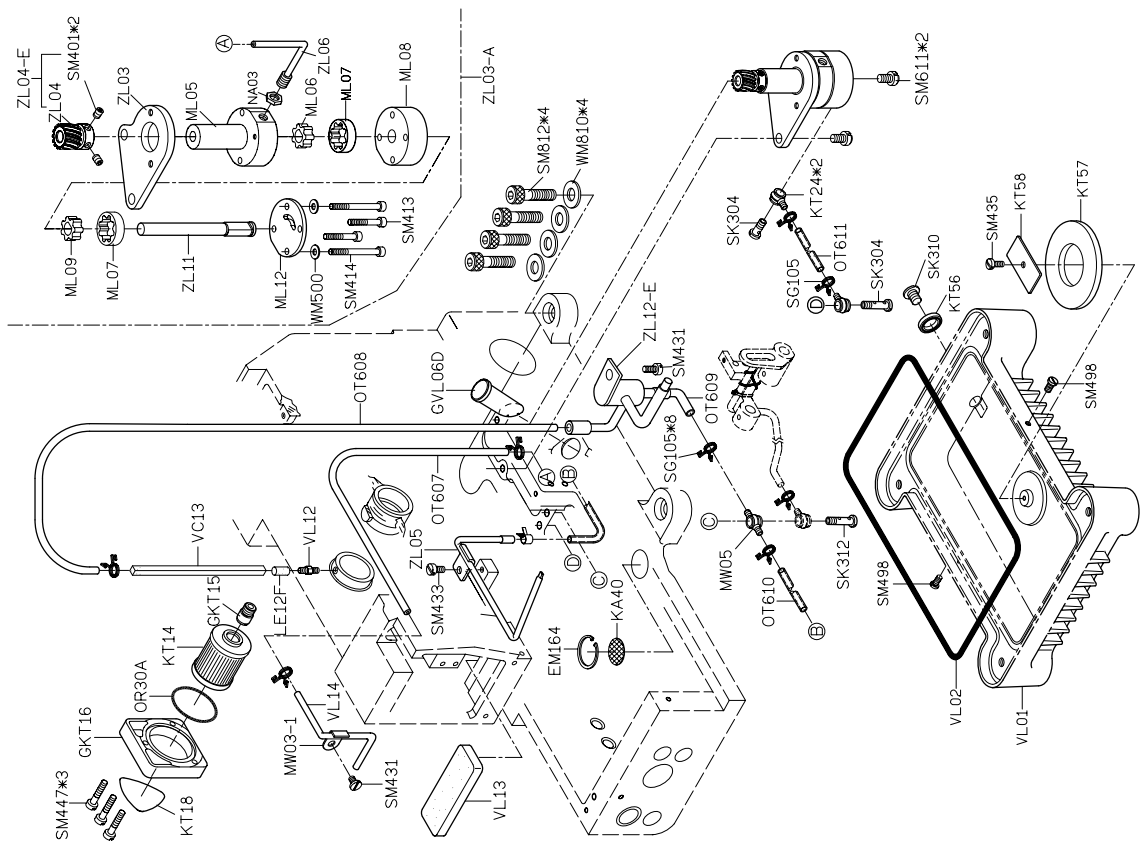
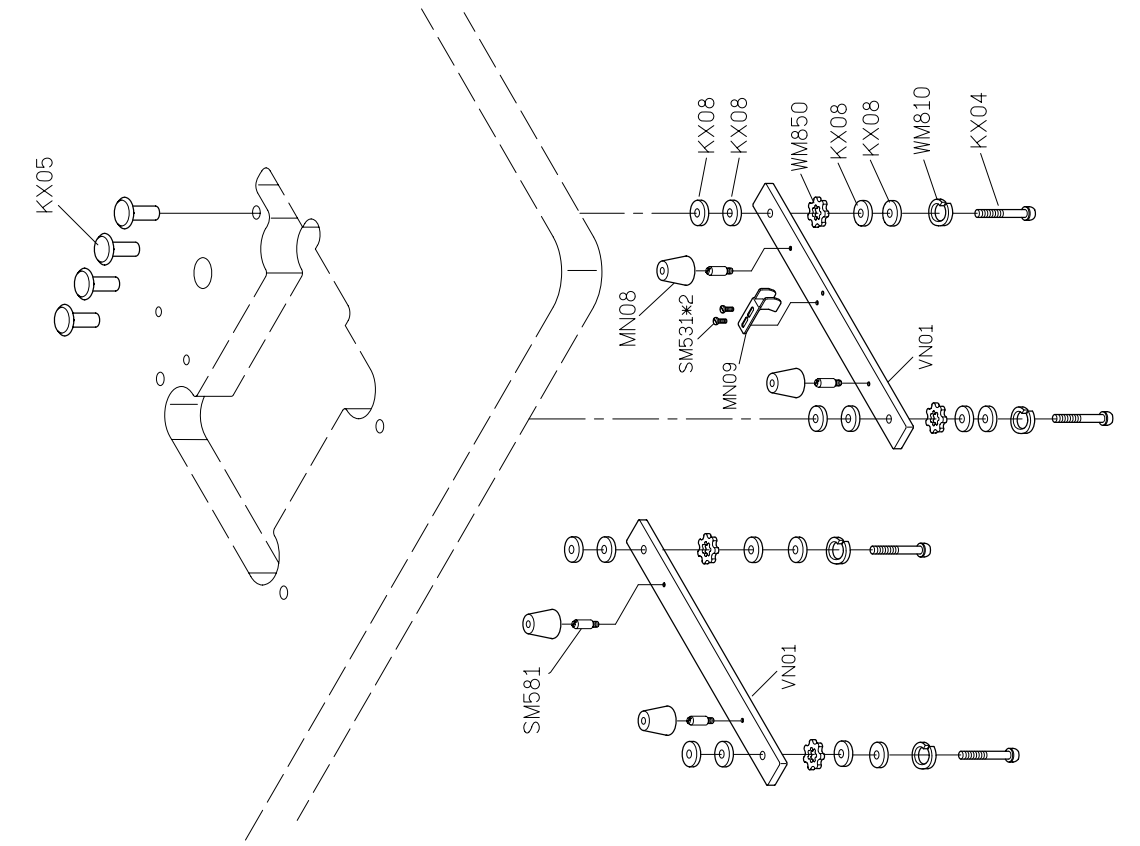

PARTS LIST FOR ZN GROUP

PARTS LIST FOR THREAD STAND GROUP

FOR 1-NEEDLE KW40E-3

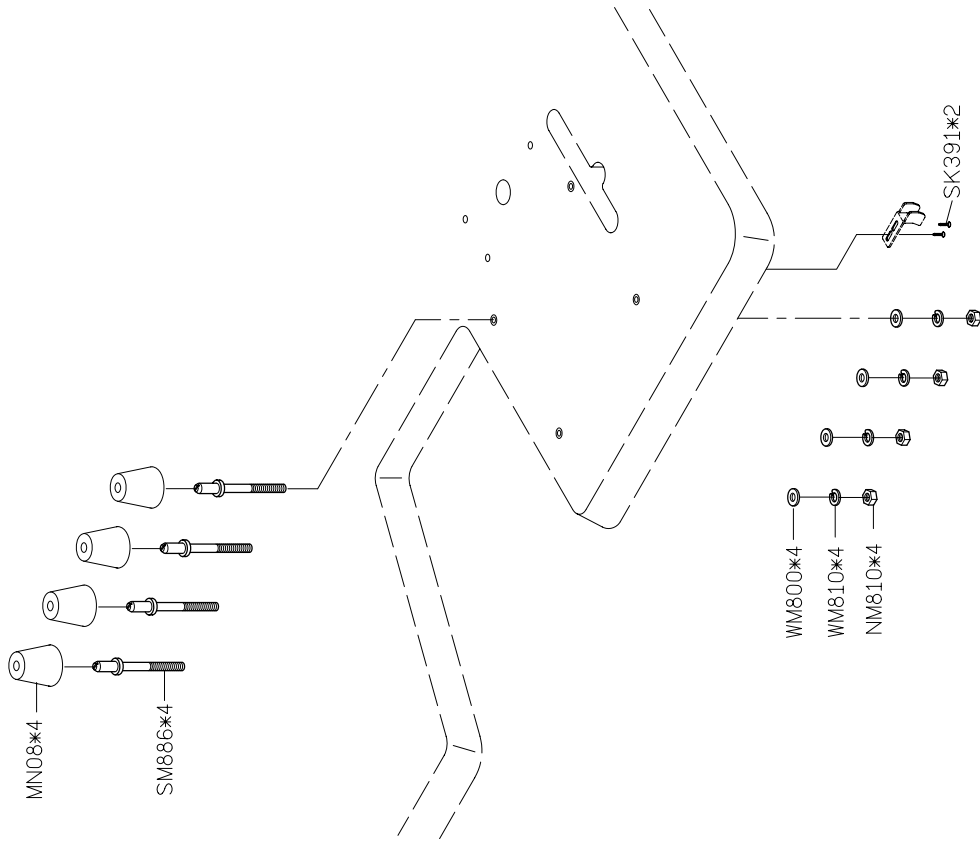
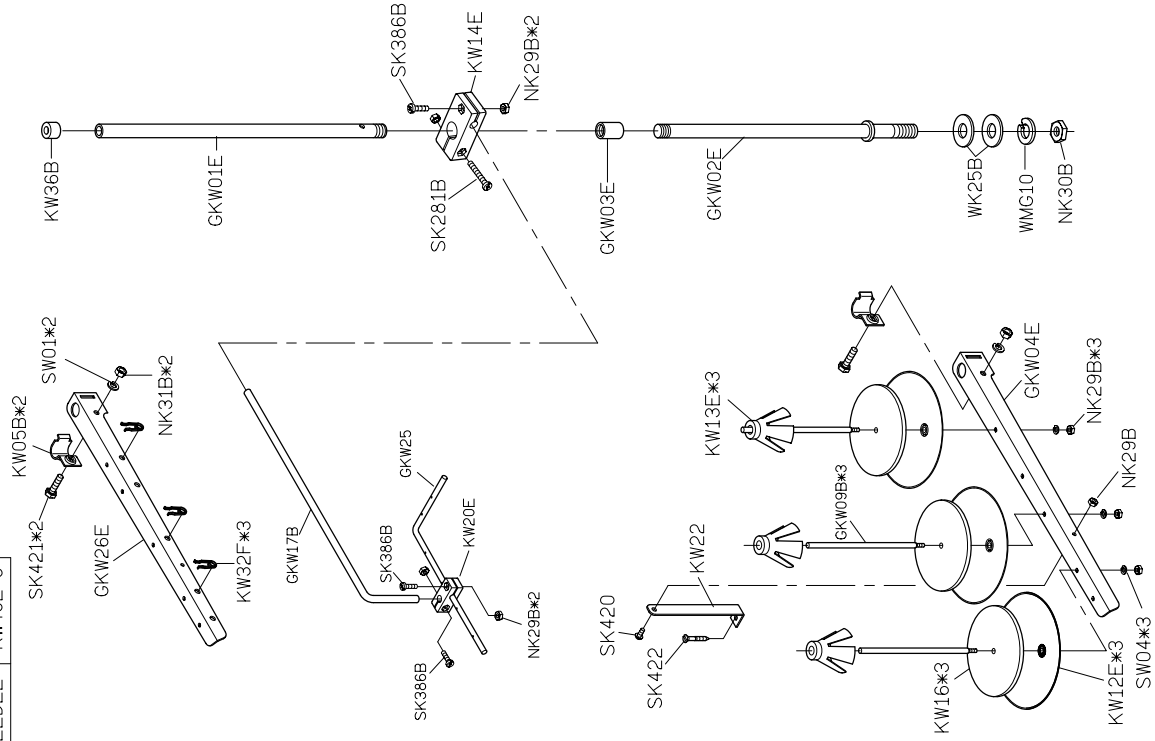

FOR 2-NEEDLE KW40E-6

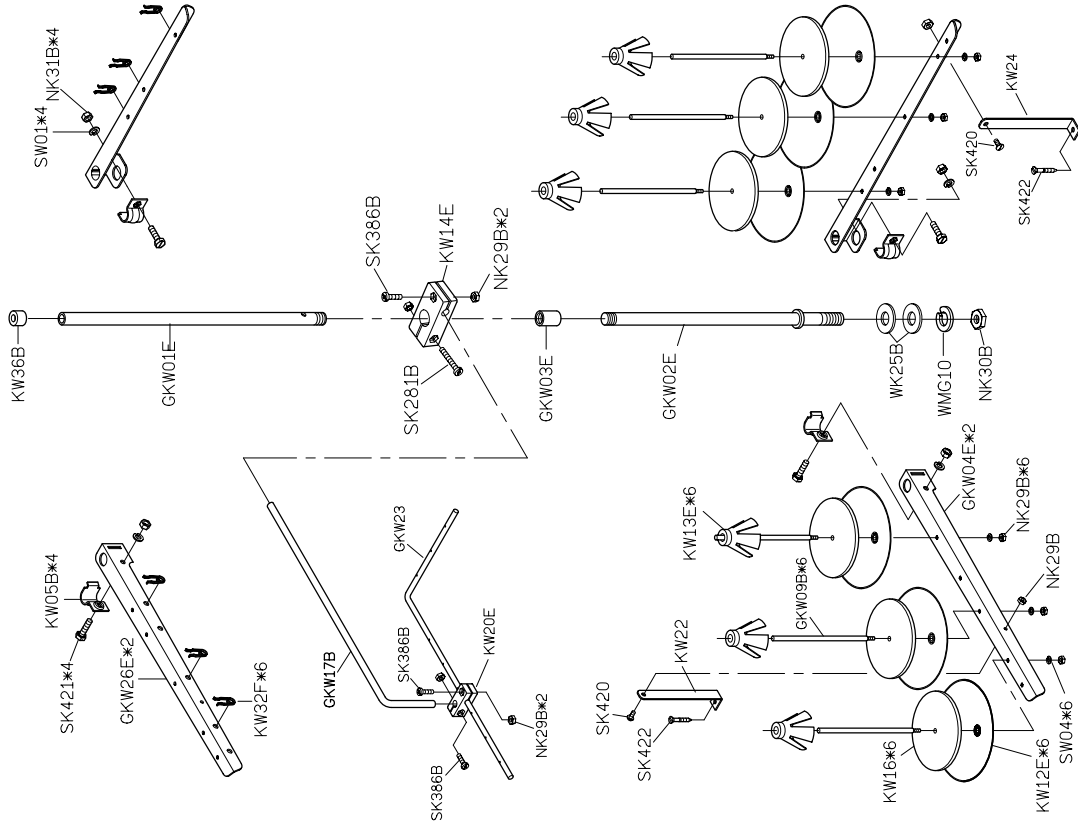

GMY01
防塵罩



KY02-A
油罐

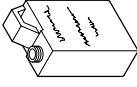

KY03
油壺



KY04
漏斗



KZ03
乾燥劑



KY07
開口板手



KY08
開口板手



KY09
開口板手



MY09
六角板手



MY08
六角板手



MY10
六角板手



MY11
六角板手



MY12
六角板手



KY11
六角板手



KY14
內六角螺絲起子



KY16
一字起子

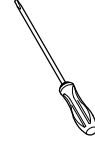

KY17
一字起子



KY18
鑷子



KY14
濾油器



GKY26F
工具袋



GKY20D
腳踏板



KY21-1/MY21
鉤子/鍊條



ZY04
零件圖



ZY02
使用說明書



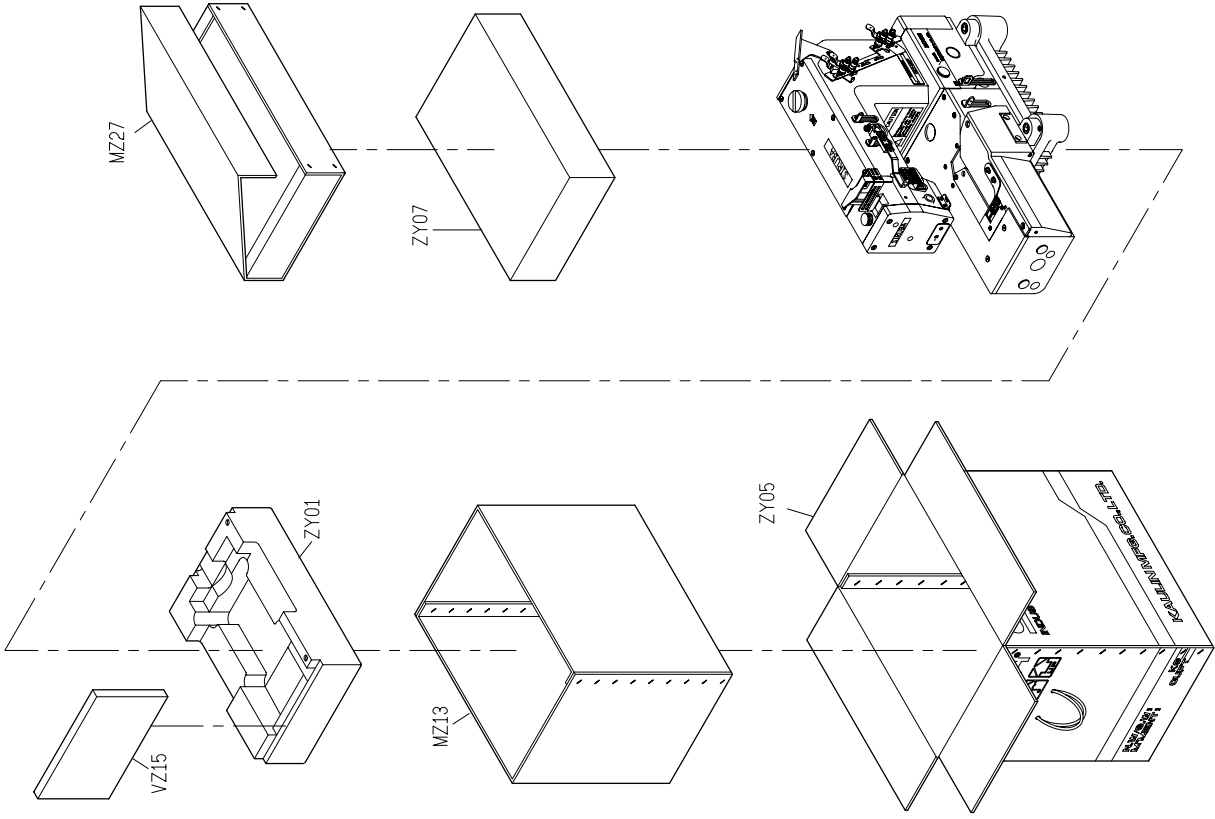



Z008

高林股份有限公司 KAULIN MFG. CO., LTD.