

SIRUBA®

銀爺牌工業用縫紉機

INDUSTRIAL SEWING MACHINE

700DFT









零件圖 PARTS LIST

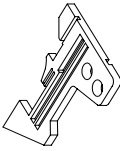
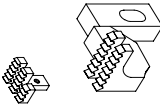
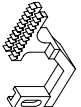

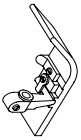
CE



高林股份有限公司
KAULIN MFG. CO., LTD.

機 型 MODEL	 針板 NEEDLE PLATE	 送具 FEED DOG	 送具 FEED DOG	 送具 FEED DOG	 押具 PRESSER FOOT	 勾 針 LOOPER	 針 留 NEEDLE CLAMP	 束 子 COLLER	 衝 程 CRANK	 衝 程 CRANK	 針 號 NEEDLE
747DFT-514H4-24	E919	D440 D095	H445	D453	P454-A	LP38	KG142-E	KJ13F	TF157-A	KJ11B	DC27 #9*2
747DFT-514H4-24GB	E919	D440 D095	H445	D453	P454-A	LP38	KG142-E	KJ13F	TF157-A	KJ11B	DC27 #9*2
747DFT-514H4-24GB/P	E919	D440 D095	H445	D453	P454P-A	LP38	KG142-E	KJ13F	TF157-A	KJ11B	DC27 #9*2
747DFT-514H4-24GB/PB	E919	D440 D095	H445	D453	P454-A	LP38	KG142-E	KJ13F	TF157-A	KJ11B	DC27 #9*2
747DFT-514M2-24	E919	D440 D095	H445	D453	P454-A	LP38	KG142-E	KJ13F	TF157-A	KJ11B	DC27 #9*2
747DFT-514M2-24DT	E919C	D440 D095	H445	D453	P454-A	LP38	KG142-E	KJ13F	TF157-A	KJ11B	DC27 #9*2
757DFT-516H4-35	E861	D489 D502	H497	D469	P466-A	LP38	KG153-E	KJ13F	TF157-A	KJ11B	DC27 #14*2
757DFT-516H4-35GB	E861	D489 D502	H497	D469	P466-A	LP38	KG153-E	KJ13F	TF157-A	KJ11B	DC27 #14*2
757DFT-516H4-35GB/P	E861	D489 D502	H497	D469	P466P-A	LP38	KG153-E	KJ13F	TF157-A	KJ11B	DC27 #14*2
757DFT-516H4-35GB/PB	E861	D489 D502	H497	D469	P466-A	LP38	KG153-E	KJ13F	TF157-A	KJ11B	DC27 #14*2
757DFT-516H4-56	E866	D489 D502	H500	D469	P463-A	LP38	KG155-E	KJ13F	TF157-A	KJ11B	DC27 #14*2
757DFT-516H4-56GB	E866	D489 D502	H500	D469	P463-A	LP38	KG155-E	KJ13F	TF157-A	KJ11B	DC27 #14*2
757DFT-516H4-56GB/P	E866	D489 D502	H500	D469	P463P-A	LP38	KG155-E	KJ13F	TF157-A	KJ11B	DC27 #14*2
757DFT-516H4-56GB/PB	E866	D489 D502	H500	D469	P463-A	LP38	KG155-E	KJ13F	TF157-A	KJ11B	DC27 #14*2
757DFT-516M2-35	E861	D489 D502	H497	D469	P466-A	LP38	KG153-E	KJ13F	TF157-A	KJ11B	DC27 #18*2
757DFT-516M2-35DT	E861C	D489 D502	H497	D469	P466-A	LP38	KG153-E	KJ13F	TF157-A	KJ11B	DC27 #18*2
757DFT-516M2-56	E866	D489 D502	H500	D469	P463-A	LP38	KG155-E	KJ13F	TF157-A	KJ11B	DC27 #14*2
757DFT-516M2-56DT	E866C	D489 D502	H500	D469	P463-A	LP38	KG155-E	KJ13F	TF157-A	KJ11B	DC27 #14*2
747DRT-514M2-24	E919	D440 D095	H445	D070	P068-4	LP38	KG142-E	KJ13F	TF157-A	KJ11B	DC27 #9*2
747DRT-514M2-24DT	E919C	D440 D095	H445	D070	P068-4	LP38	KG142-E	KJ13F	TF157-A	KJ11B	DC27 #9*2
757DRT-516M2-56	E129	D066 D067	H500	D064	P056-A	LP38	KG155-E	KJ13F	TF157-A	KJ11B	DC27 #14*2
757DRT-516M2-56DT	E129C	D066 D067	H500	D064	P056-A	LP38	KG155-E	KJ13F	TF157-A	KJ11B	DC27 #14*2
757DRT-516M2-35	E169	D066 D067	H497	D064	P053-A	LP38	KG153-E	KJ13F	TF157-A	KJ11B	DC27 #14*2
757DRT-516M2-35DT	E169C	D066 D067	H497	D064	P053-A	LP38	KG153-E	KJ13F	TF157-A	KJ11B	DC27 #14*2

規格件表 CONVERSION CHART

PARTS LIST FOR KA GROUP

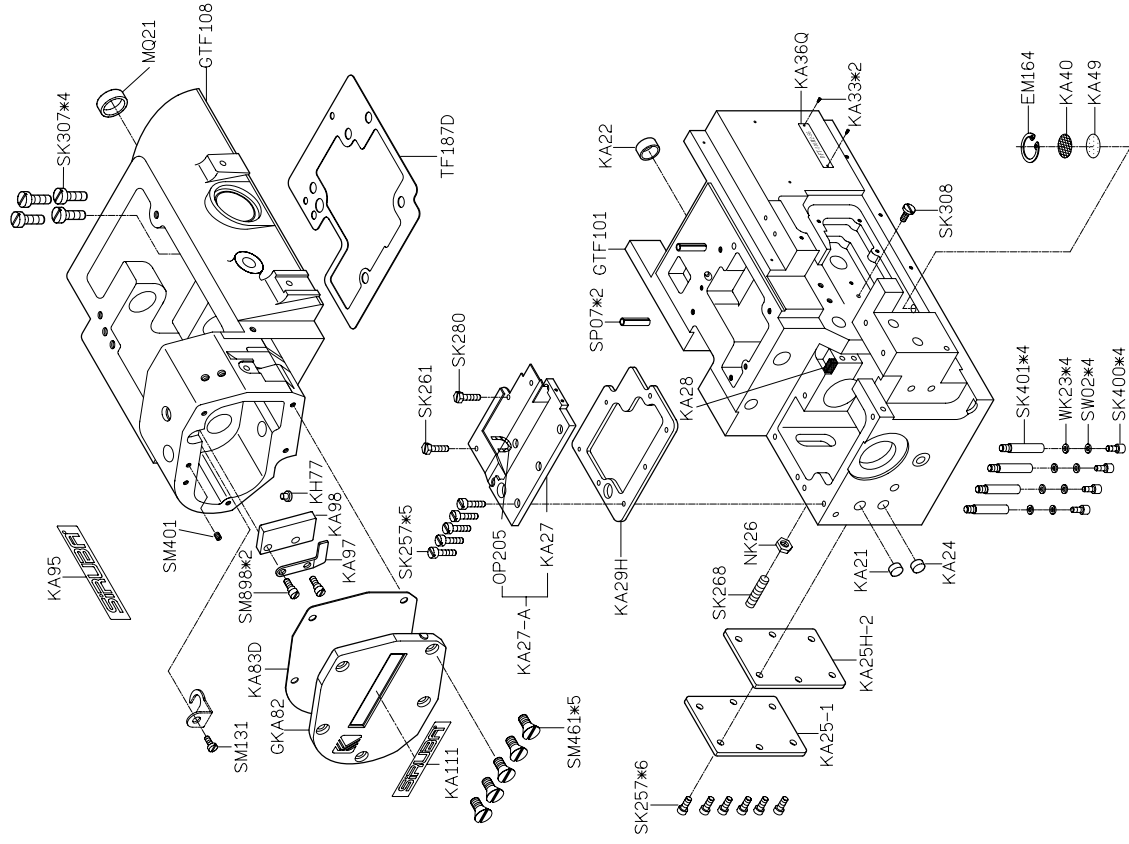

PARTS LIST FOR KB GROUP

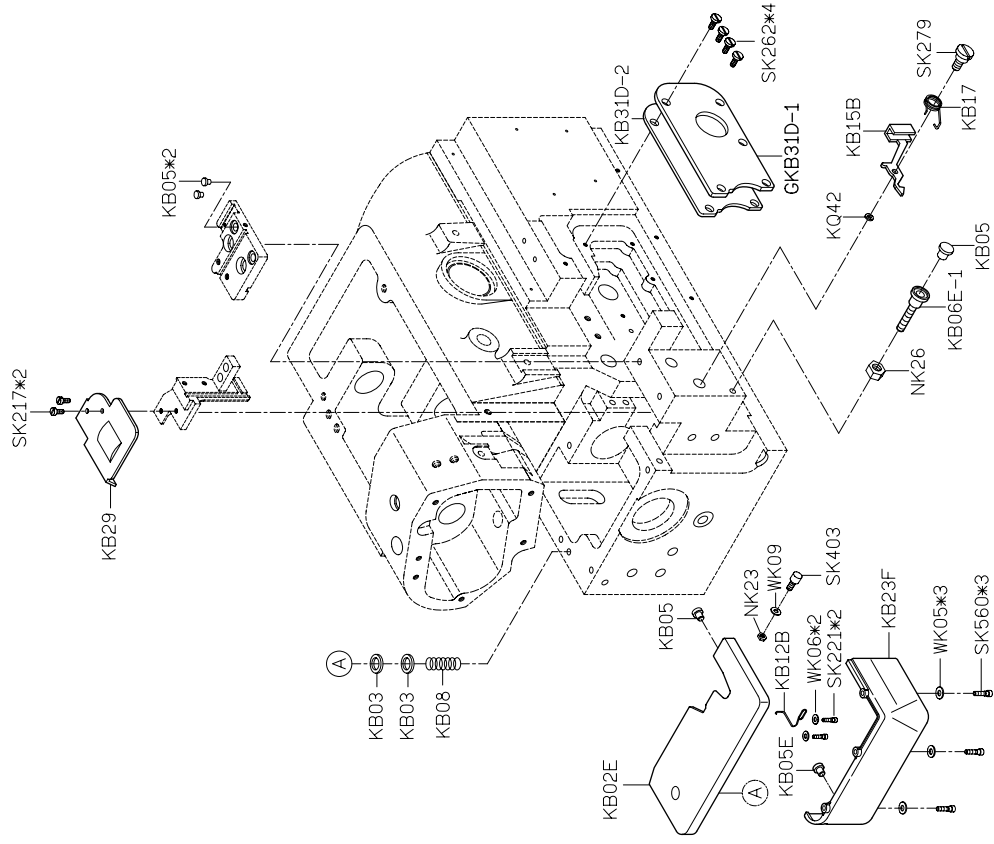

MODEL	#4	#5
PARTS NO	KC87	TF195

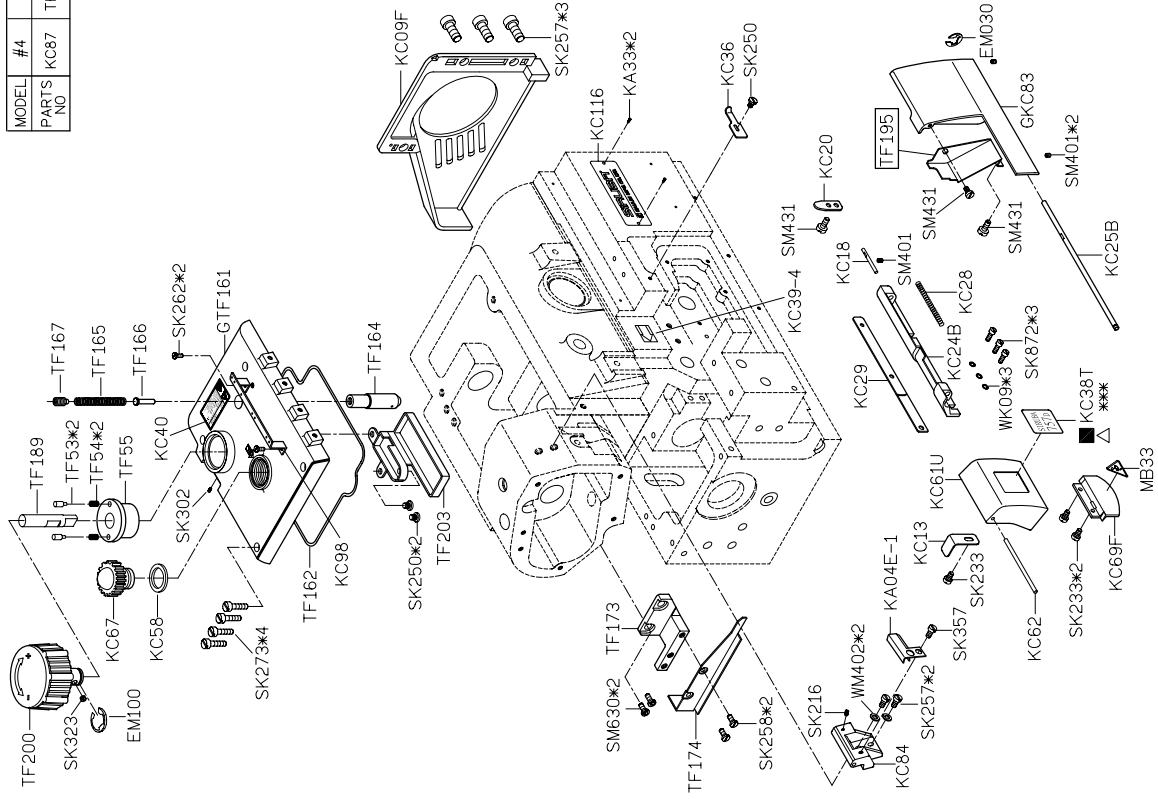

PARTS LIST FOR KC GROUP

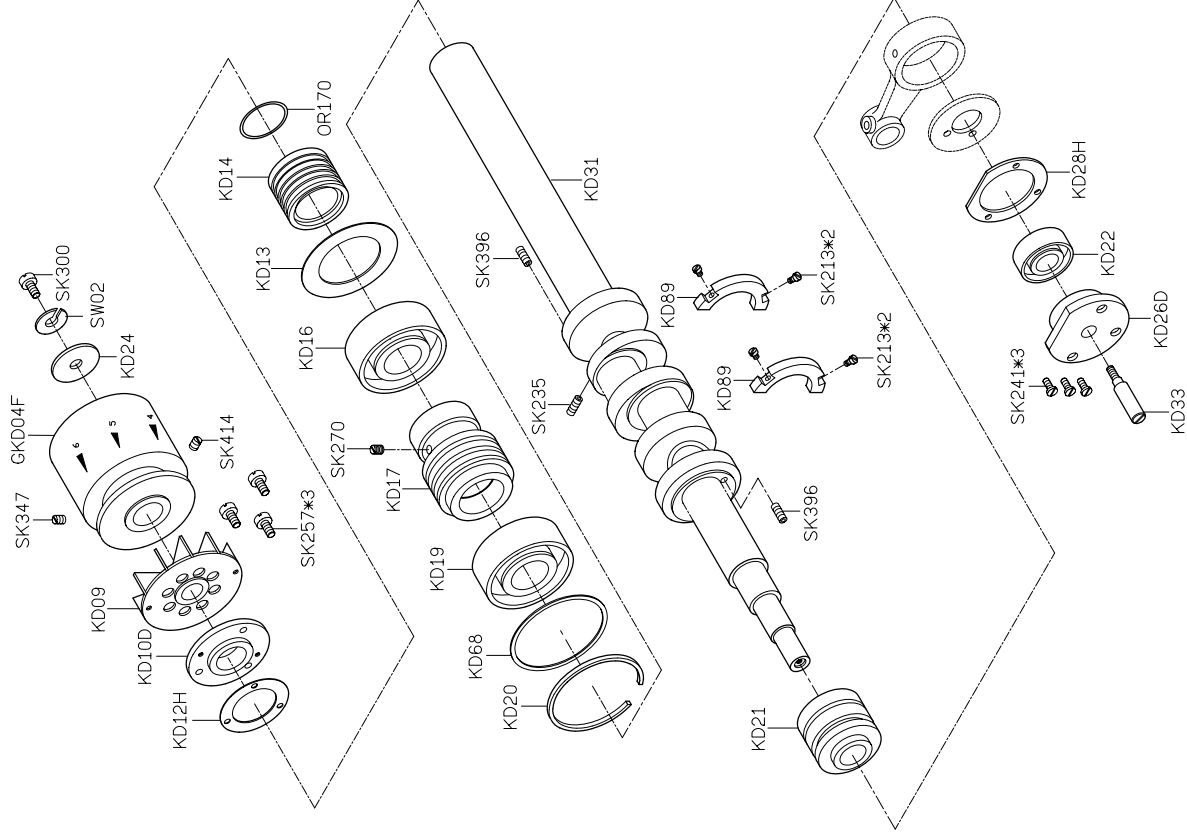

PARTS LIST FOR KD GROUP

PARTS LIST FOR KF GROUP

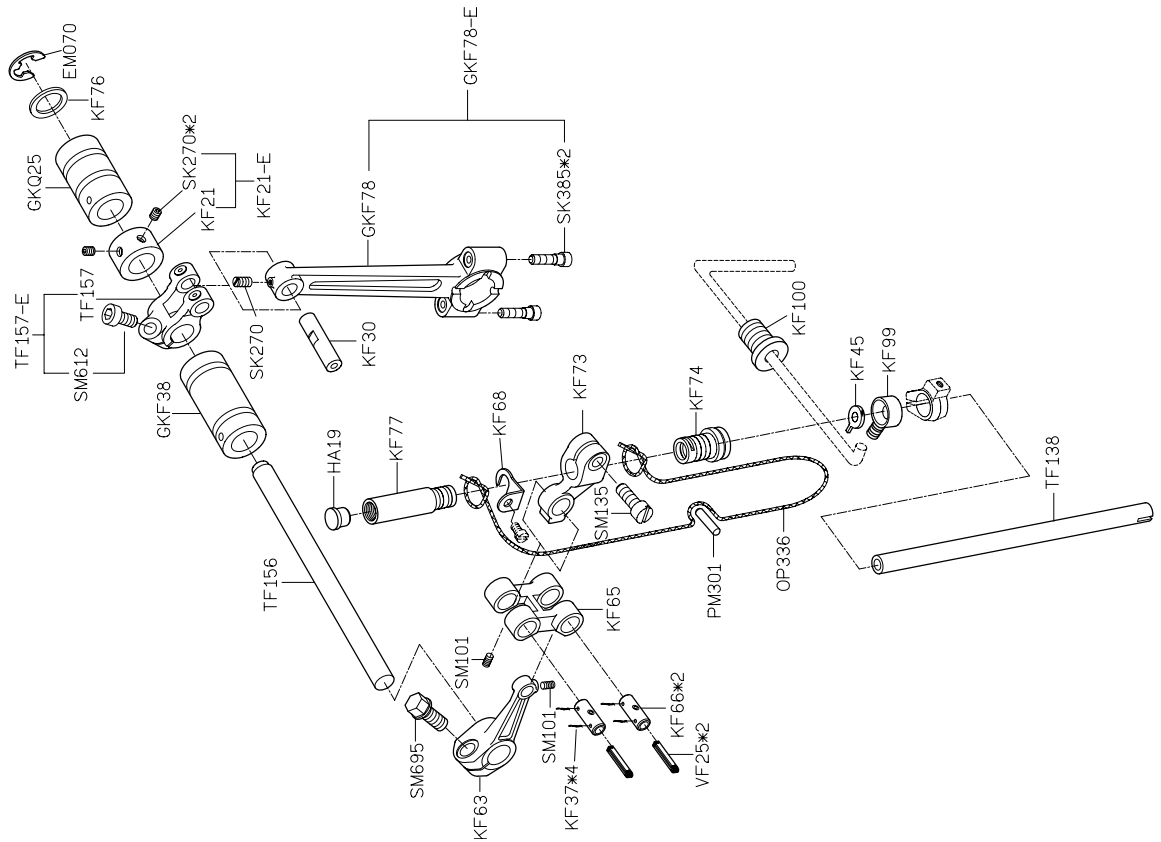

PARTS LIST FOR KG GROUP

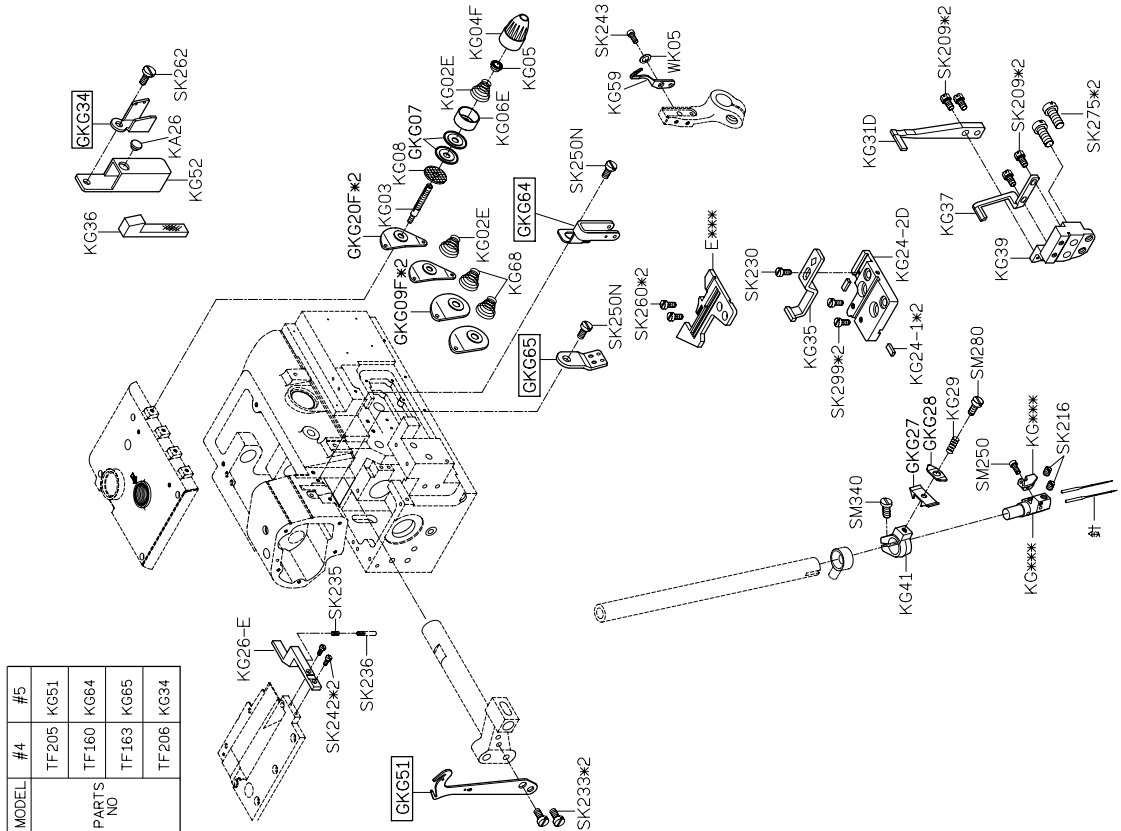

MODEL	#4	#5
	TF205	KG51
PARTS NO	TF160	KG64
	TF163	KG65
	TF206	KG34

MODEL	#4	#5
PARTS NO	KL57	KL16
	KL15	KL11
	KL12B-E	KL09B-E

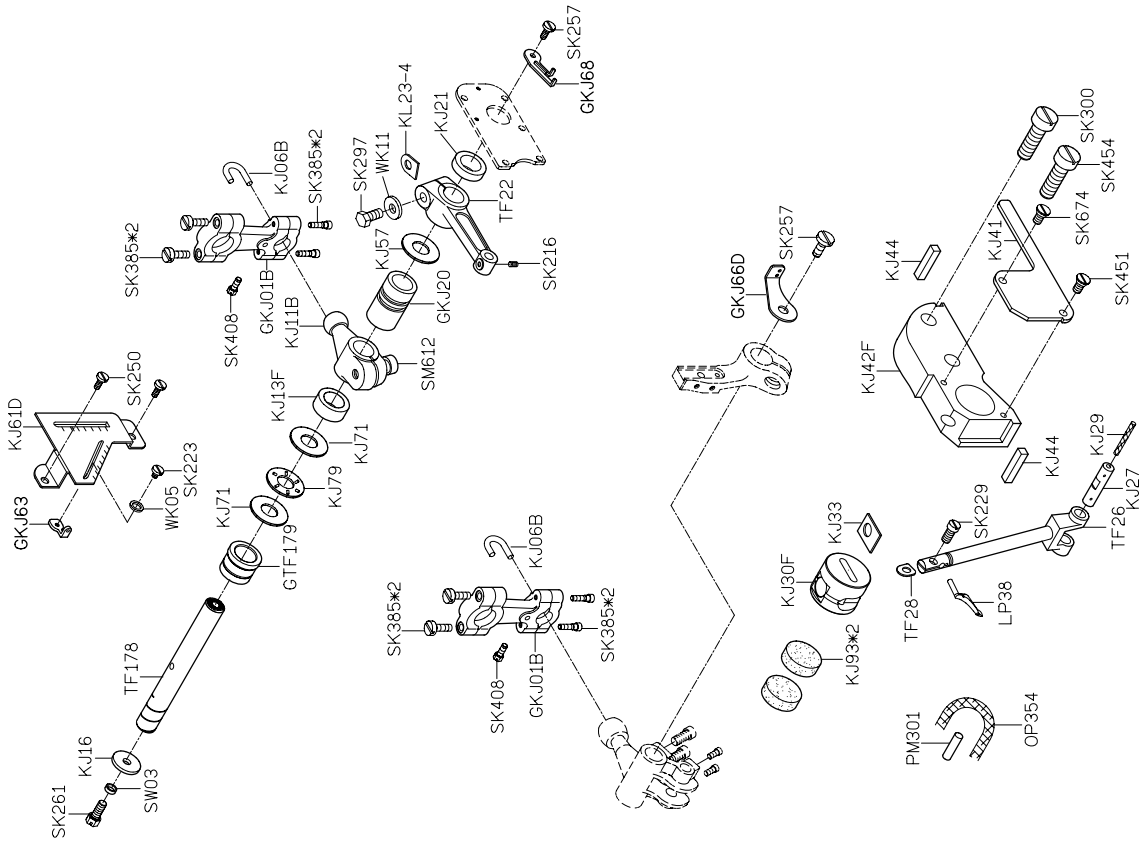
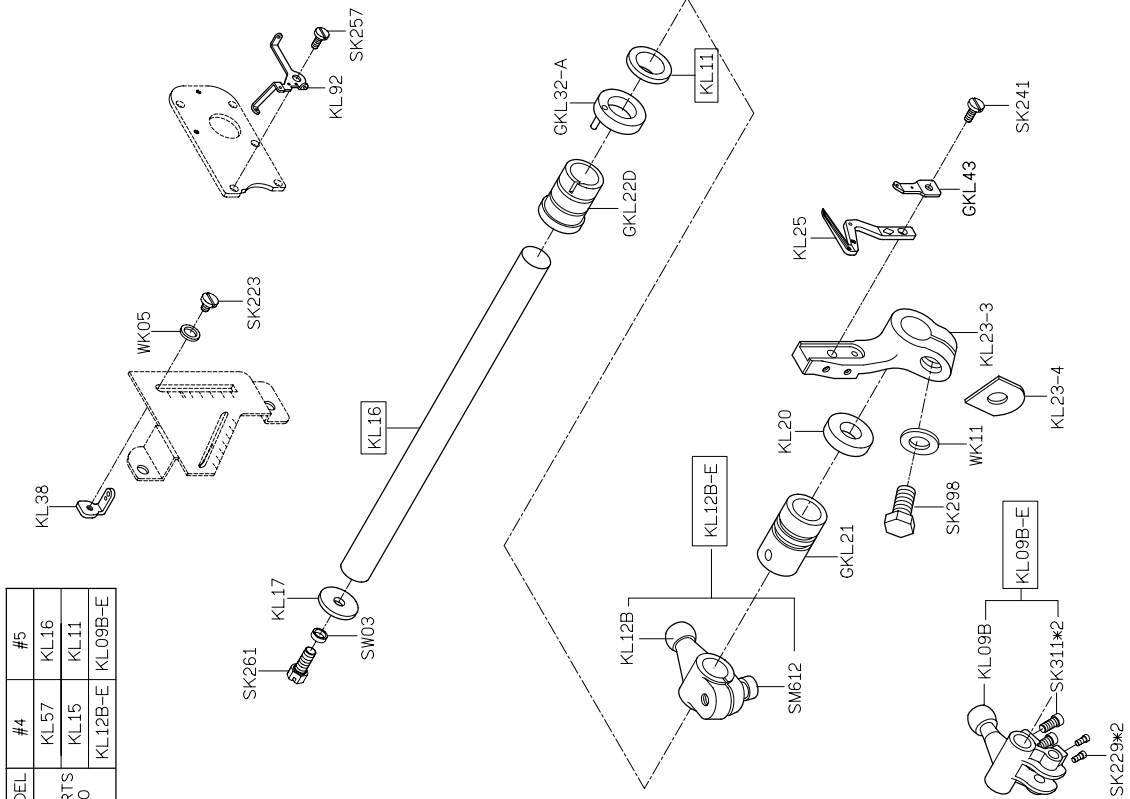

PARTS LIST FOR KM GROUP

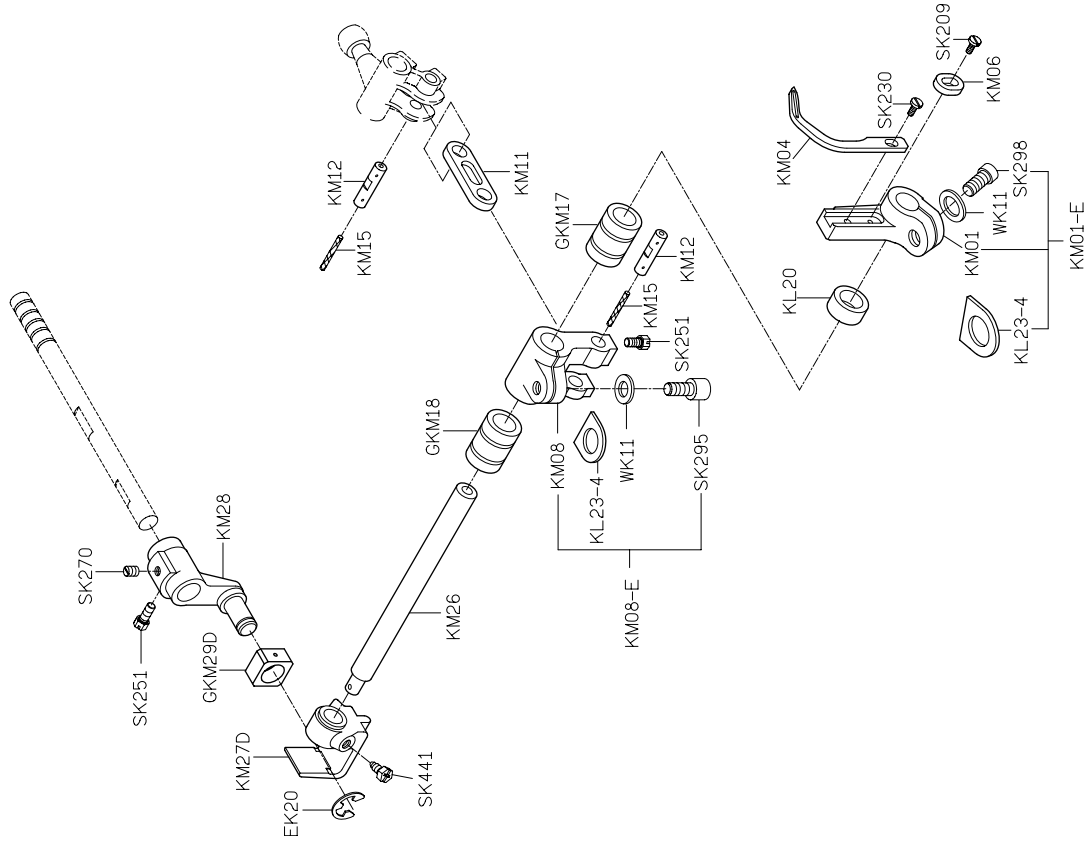

PARTS LIST FOR KN GROUP

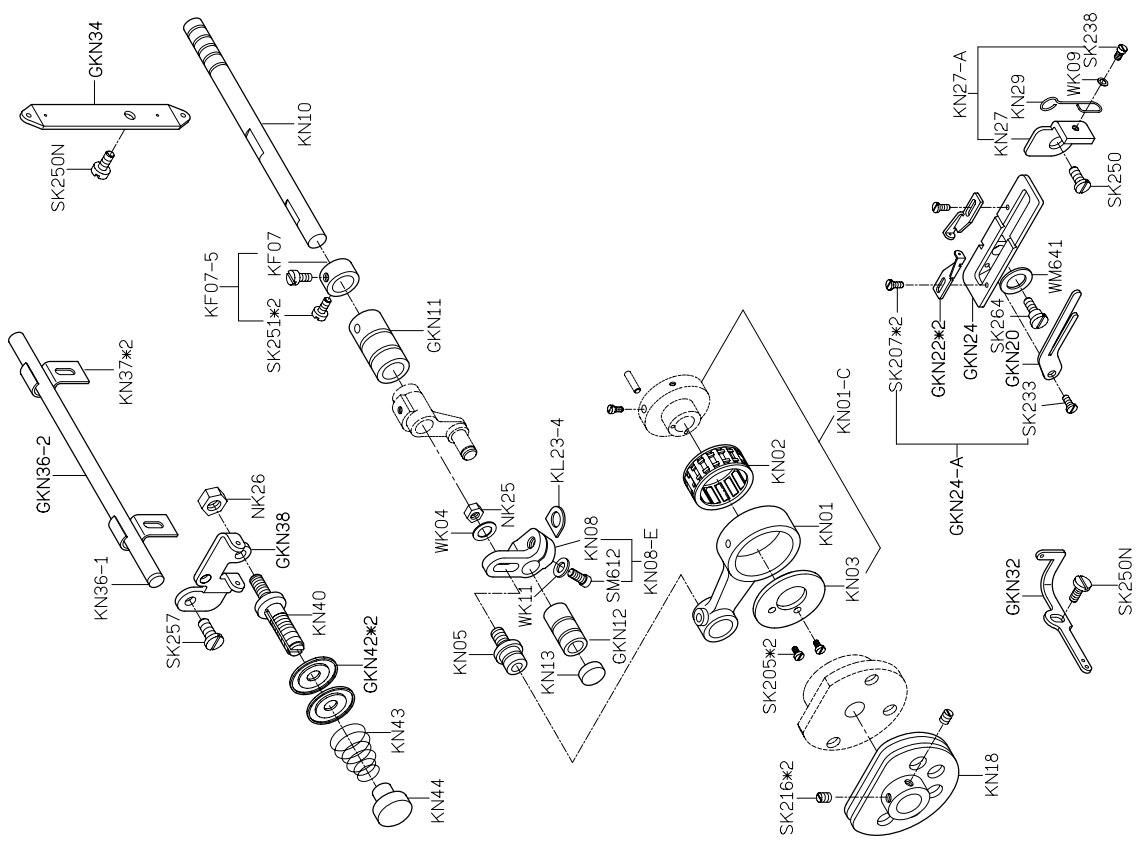

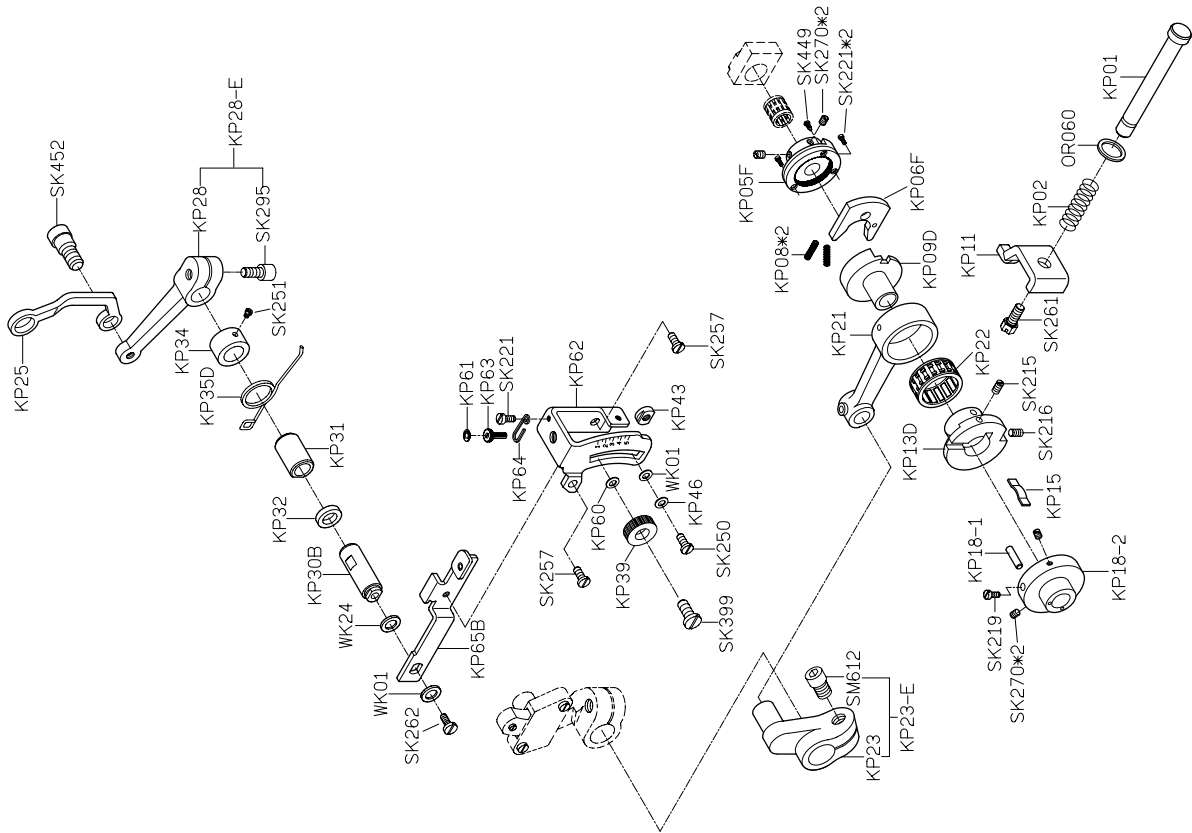

PARTS LIST FOR KP GROUP

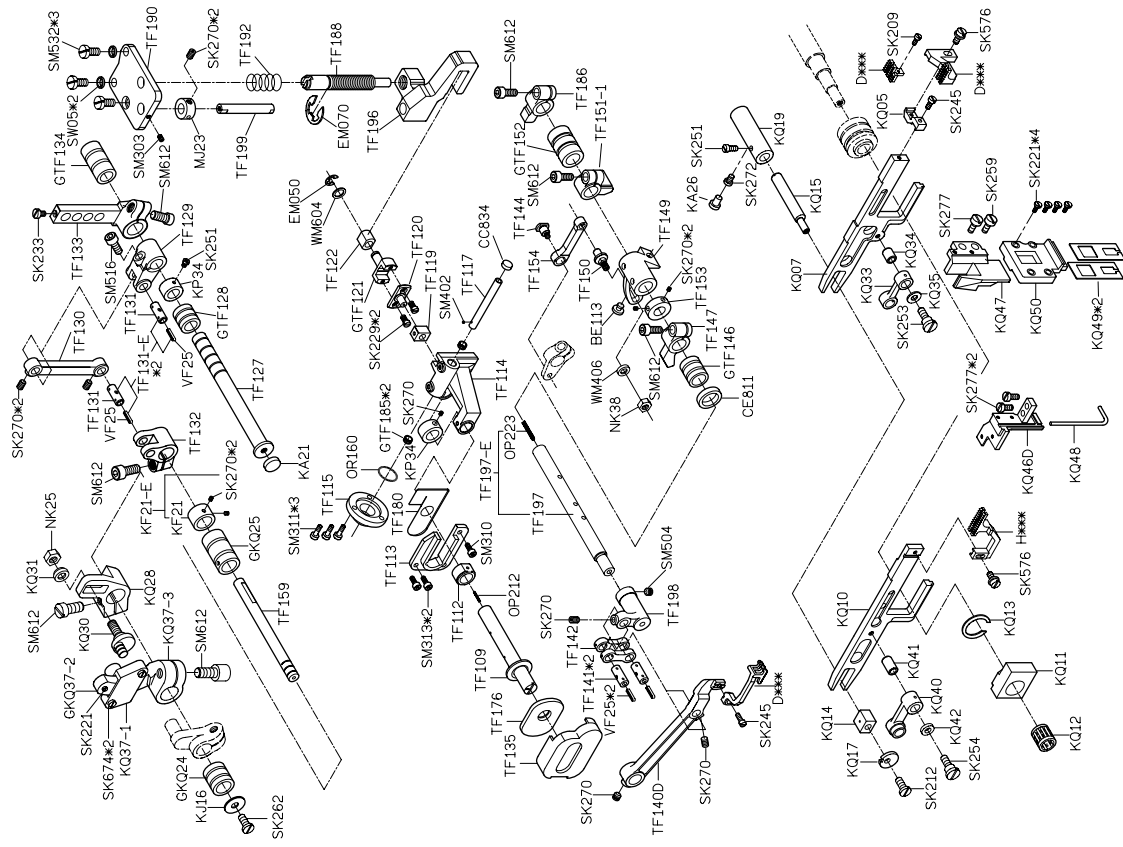

PARTS LIST FOR KQ GROUP

PARTS LIST FOR KR GROUP

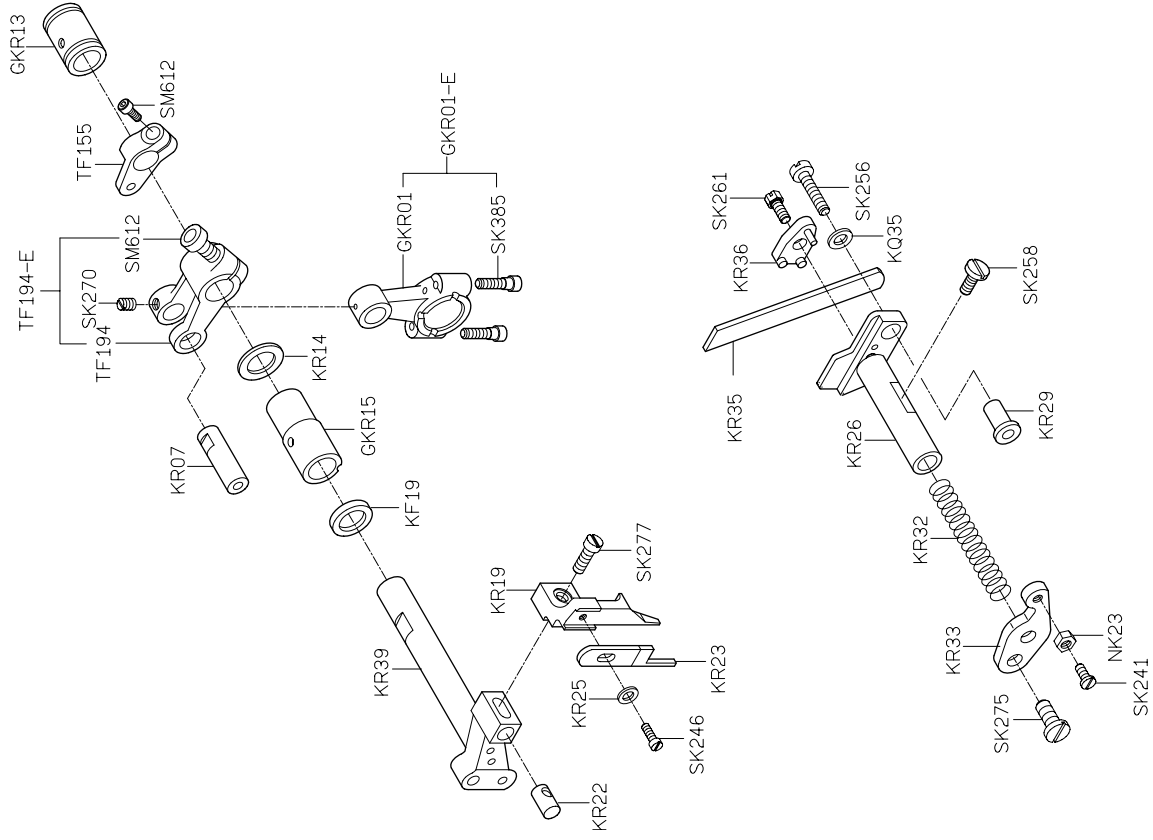

PARTS LIST FOR KS GROUP

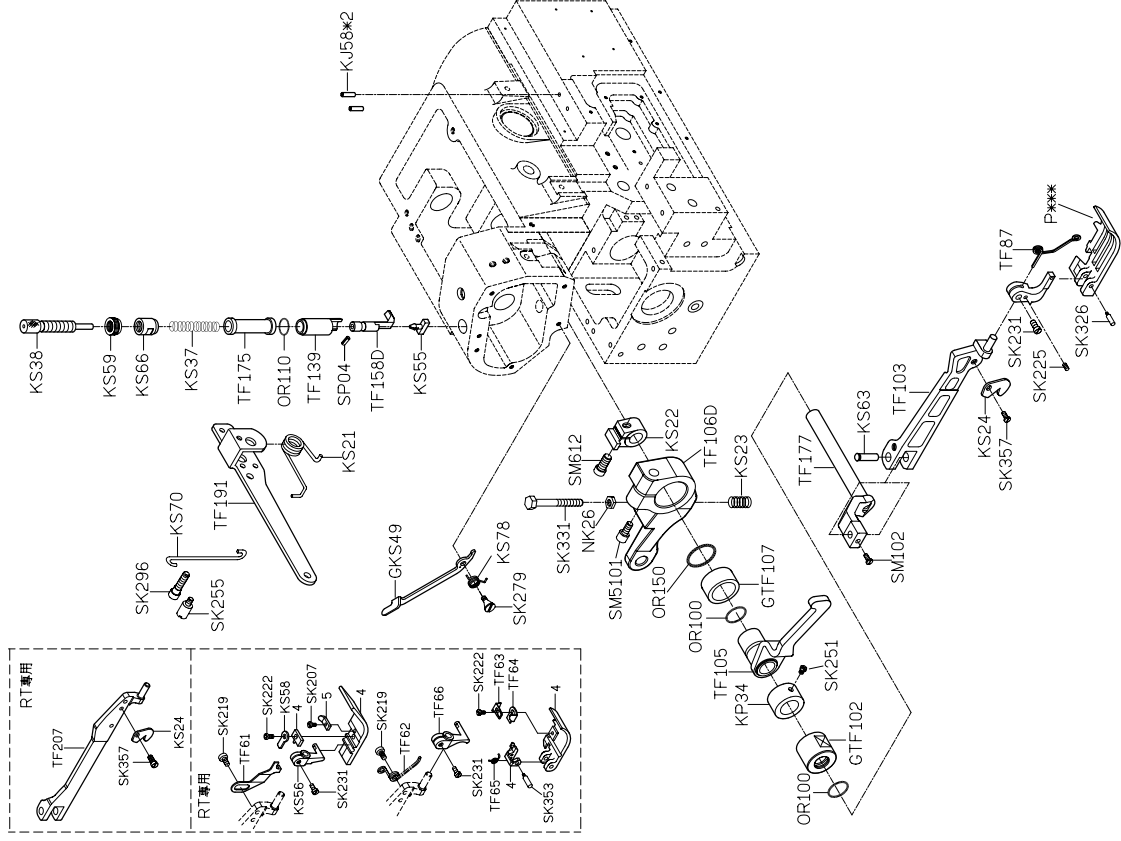

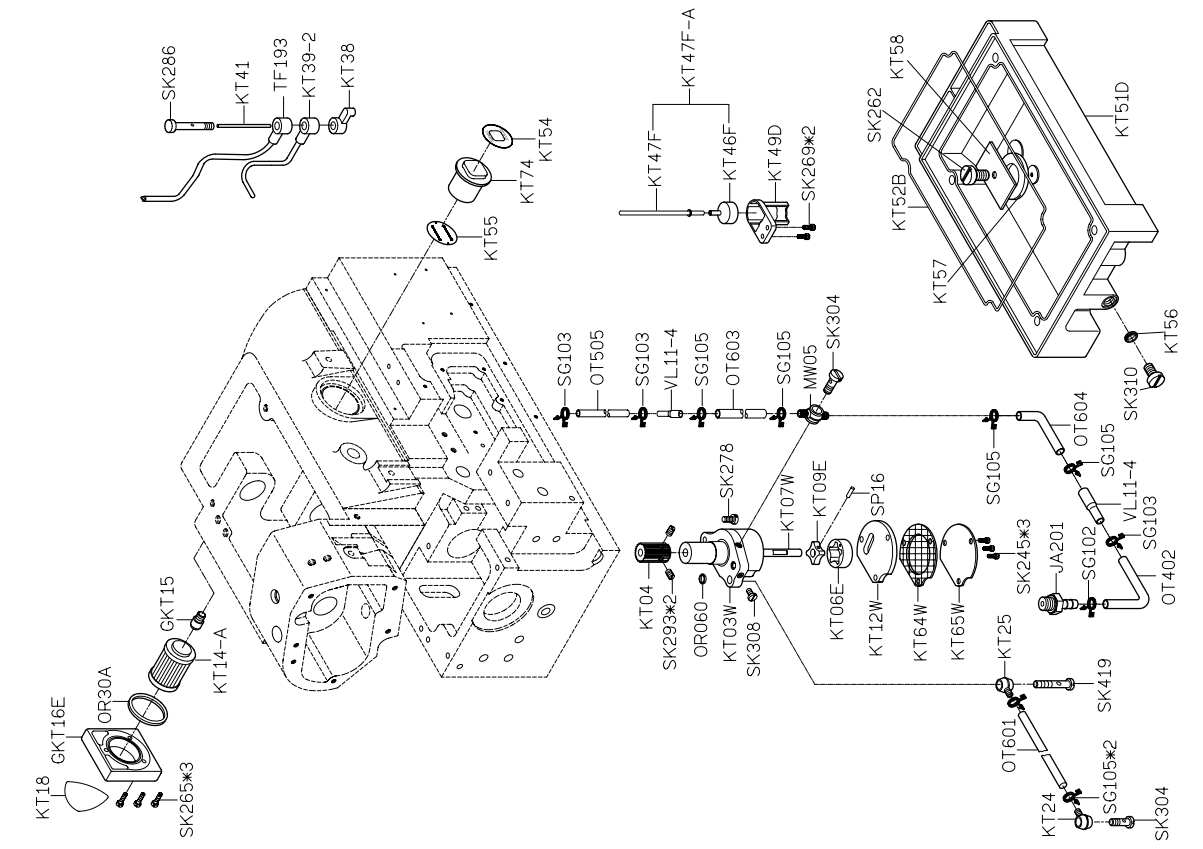

PARTS LIST FOR KT GROUP

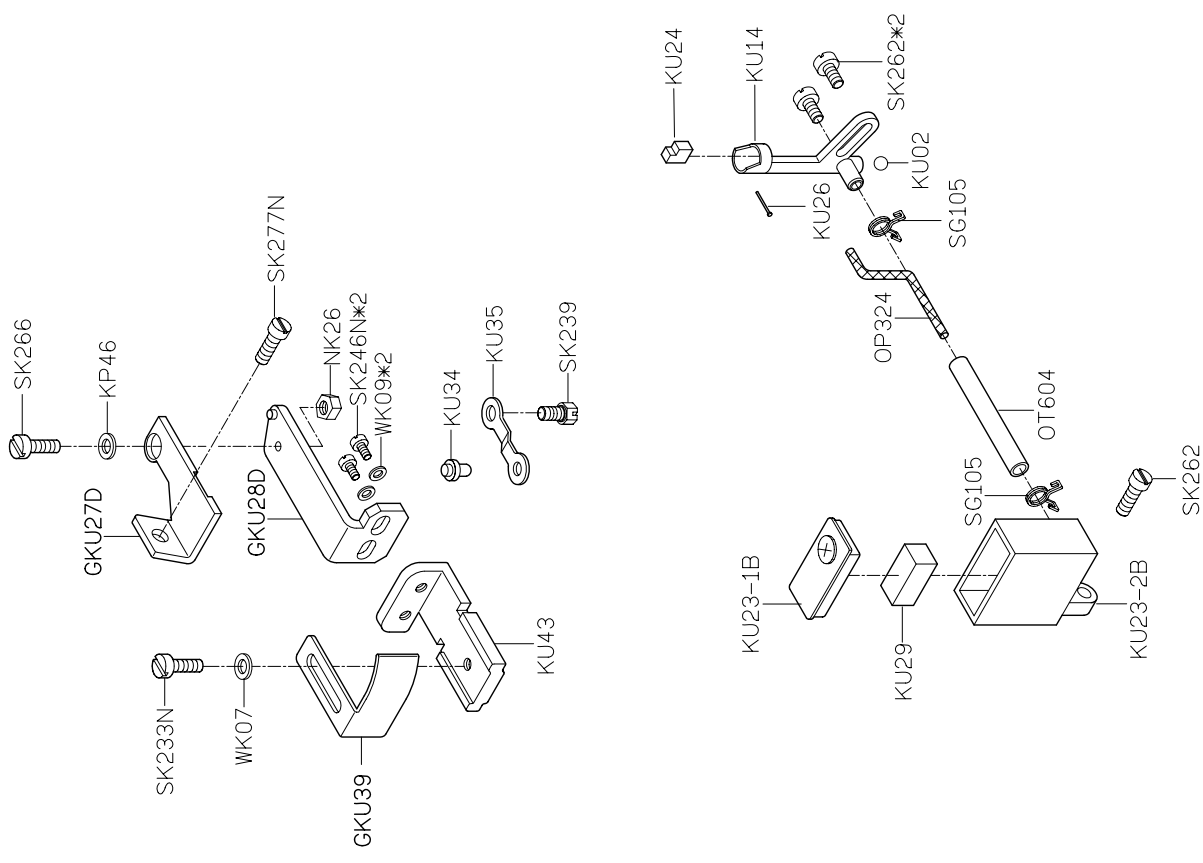

PARTS LIST FOR KU GROUP





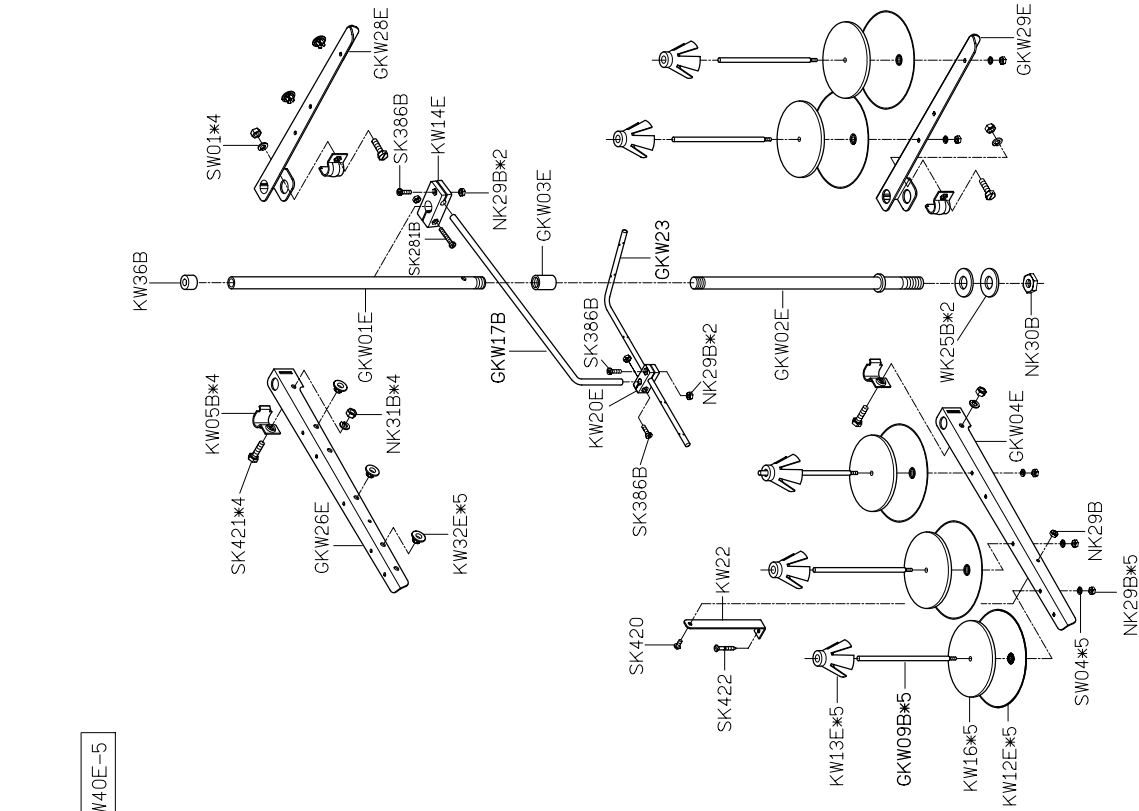



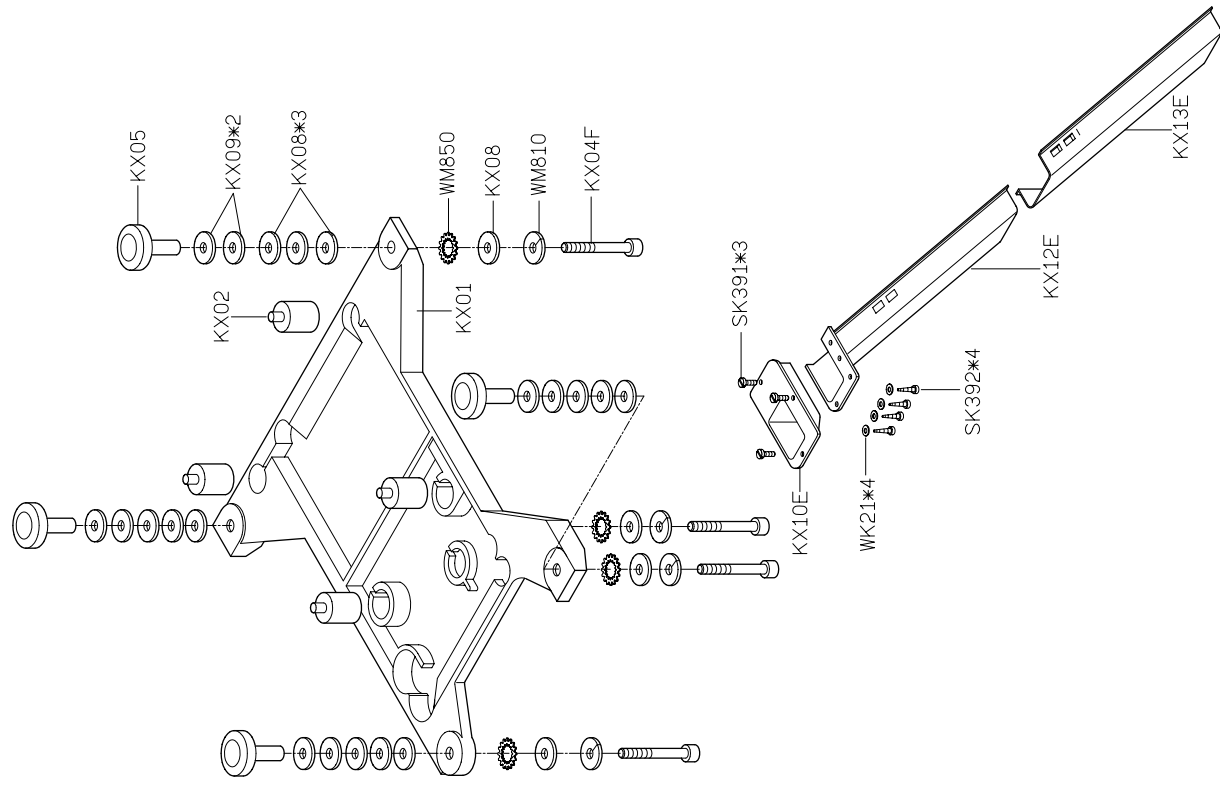

















PARTS LIST FOR KW GROUP

KW40E-5



PARTS LIST FOR KX GROUP



- | | | | | | |
|---|---|---|---|--|---|
| GKY01
防塵罩
 | KY02-A
油罐
 | KY03
油壺
 | KY04
漏斗
 | KY05
油壺
 | KY07
開口扳手
 |
| KY08
開口扳手
 | KY09
開口扳手
 | KY10
六角扳手
 | KY11
六角扳手
 | KY12
六角扳手
 | KY14
內六角螺絲起子
 |
| KY16
一字起子
 | KY17
一字起子
 | KY18
鑷子
 | KY19
穿線器
 | GKY20D
腳踏板
 | KY21-A/MY21
鉤子/螺絲
 |
| GKY26F
工具袋
 | KR35
下刀片
 | KT14-A
潤油器
 | KZ03
乾燒劑
 | 針*5
針
 | KZ08DF T /
KZ08DF T-1
使用說明書
 |
| SK216
螺絲
 | MY11
六角扳手
 | KY30
針板紙
 | | | |

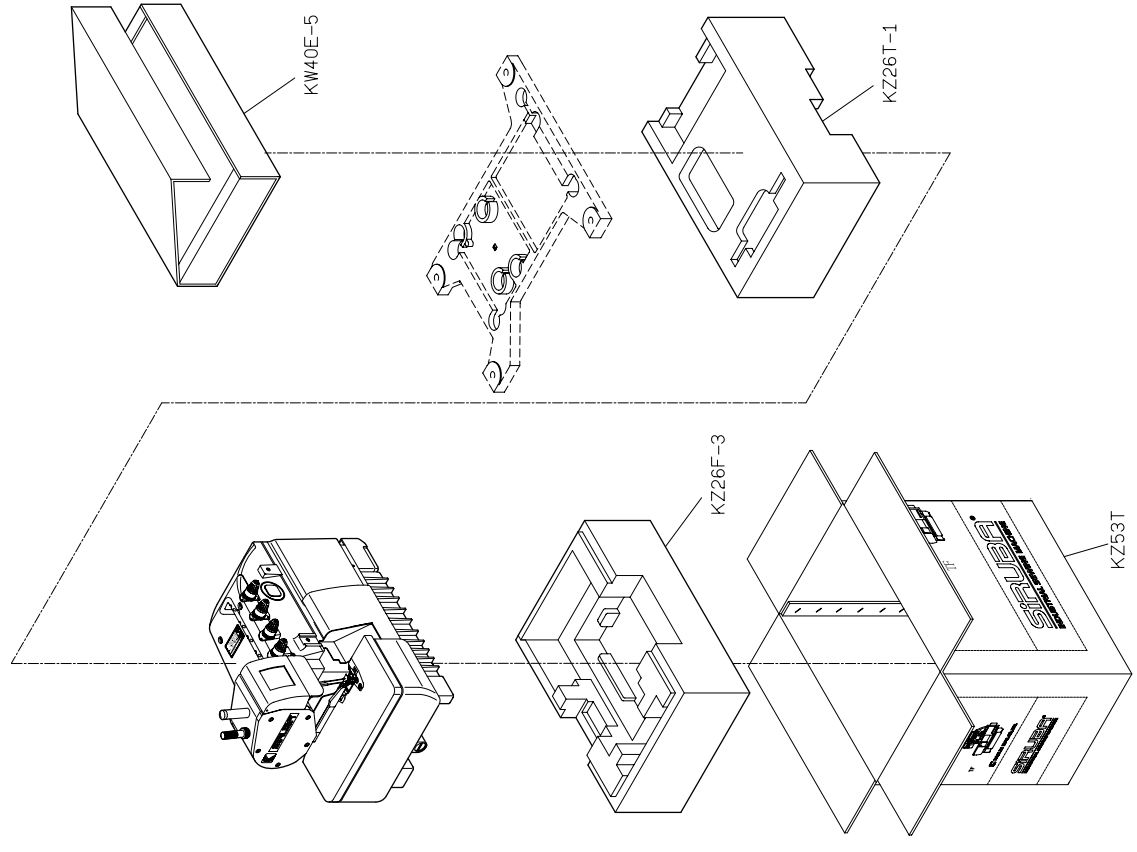



700DFT

高林股份有限公司 KAULIN MFG. CO., LTD.